



Rexnord Tollok Locking Assemblies





Why Choose Rexnord Tollok Locking Assemblies?

Why Choose Rexnord?

When it comes to providing highly engineered products that improve productivity and efficiency for industrial applications worldwide, Rexnord is the most reliable in the industry. Our commitment to customer satisfaction and superior value extends to every area of our business.

Delivering Lowest Total Cost of Ownership

The highest quality products are designed to help prevent equipment downtime, increase productivity and deliver dependable operation.

Valuable Expertise

An extensive product offering is accompanied by global sales specialists, customer service and maintenance support teams, available anytime.

Solutions to Enhance Ease of Doing Business

Our commitment to operational excellence means you benefit from getting the right products to the right place at the right time.

Proven Reliability, Dependable Expertise, Broad Range of Options

For more than 35 years, Tollok® products have led the industry in locking assemblies. Our robust product offering features a wide range of options from simple and compact designs to advanced features. Our full line of locking assemblies can be customized to fit our customers ever-changing application needs and are ideal for use in heavy-duty and specially engineered environments.

Deliver Lower Total Cost of Ownership

Tollok designs its product by using state-of-the-art analysis tools to assure the most accurate designs possible. CAD drawings are directly integrated in a production system through CAD-CAM technology. This combined with the latest manufacturing methodology ensures high precision products with a short lead time.

Connecting Technology with Application Solutions

Tollok offers a broad range of internal locking assemblies, shrink discs and rigid couplings to fit to a wide range of applications. Tollok locking assemblies could be an alternative to a shaft/hub connection such as: key, splined, press fit, QD bushing or Taper Lock bushing. Tollok products are dimensionally interchangeable with most industry standard units.

Connecting Technology with the Best Service

Our product line is complemented with industry leading service. Each unit is protected, packed and suitably prepared for shipping. Tollok products are distributed worldwide. Regardless of the location, our customers can rely on our experienced application engineers for technical support.

Industries Served

Aggregates
Agriculture
Air Handling
Cement
Forest Products
Mining

Oil & Gas
Petrochemical
Primary Metals
Power Generation
Water Treatment

Locking assemblies

TLK110
Page 8

Self-centering
Medium-high torque
Available from 1/4 to 4 15/16 inch diameter
Available from 6 to 140 mm diameter
Low surface pressures

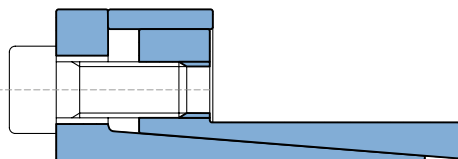

TLK 111
Page 11

Self-centering
Medium torque
Available from 14 mm to 65 mm diameter
Restricted radial encumbrance

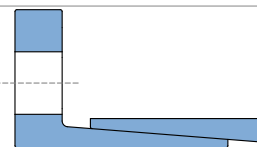

TLK130
Page 13

Self-centering
High torque
Available from 3/4 to 4 inch diameter
Available from 20 to 220 mm diameter
Quick installation
Excellent shaft/hub perpendicularity

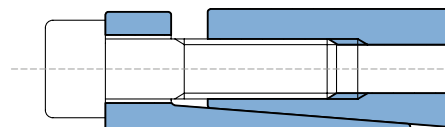

TLK131
Page 13

Self-centering
Medium-high torque
Available from 3/4 to 4 inch diameter
Available from 20 to 220 mm diameter
Low surface pressures
Excellent shaft/hub perpendicularity

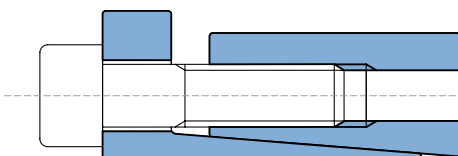

TLK132/139
Page 16 / Page 24

Self-centering
Medium torque
TLK 132: Available from 3/4 to 8 inch diameter
TLK 132: Available from 20 to 220 mm diameter
TLK 139: Available from 18 to 90 mm diameter
Compact space

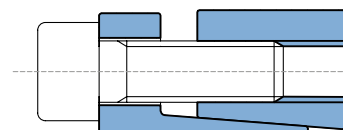

TLK133/134
Page 16 / Page 19

Self-centering
Medium torque
TLK 133: Available from 3/4 to 8 inch diameter
TLK 133: Available from 20 to 220 mm diameter
TLK 134: Available from 14 to 50 mm diameter
Compact space, excellent substitute for TLK200

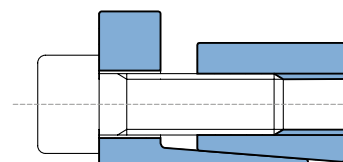

TLK 136
Page 20

Self-centering
High torque
High capacity to absorb bending moment
Available from 100 mm to 600 mm diameter

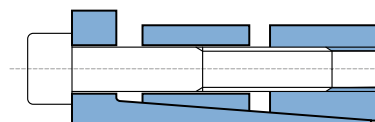

TLK138
Page 22

Self-centering
Medium-low torque
TLK 138: Available from 1/4 to 1 3/8 inch diameter
TLK 138: Available from 6 to 35 mm diameter
Excellent solution for inch hub i.d.

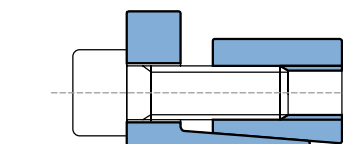

TLK200
Page 25

Not self-centering
Medium torque
Available from 3/4 to 8 inch diameter
Available from 19 to 900 mm diameter
Self-releasing, compact space

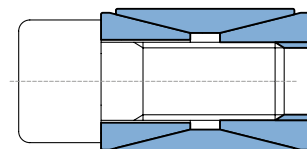

TLK250/250L
Page 28

Low torque
Available from 14 to 70 mm diameter
TLK 250: not self-centering; self-releasing
TLK 250L: self-centering
Quick installation

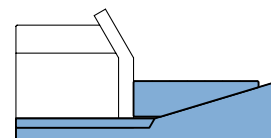

Locking assemblies

TLK300
Page 30

Not self-centering
Low torque
Available from 5 to 540 mm diameter
Compact space, self-releasing

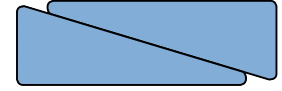

TLK350
Page 32

Self-centering
Medium-high torque
Available from 1/4 to 1 15/16 inch diameter
Available from 6 to 50 mm diameter
Quick installation

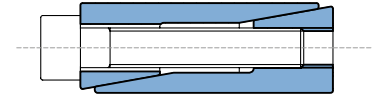

TLK400/401
Page 34

Self-centering
Very high torque
TLK400: Available from 45 to 400 mm diameter
TLK401: Available from 70 to 340 mm diameter
Even pressures distribution

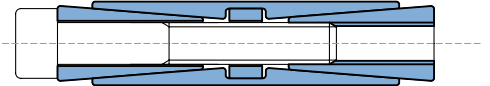

TLK450/451/452
Page 36

Self-centering
Very high torque
TLK450: Available from 1 to 8 inch diameter
TLK450: Available from 25 to 400 mm diameter
TLK451: Available from 70 to 600 mm diameter
TLK452: Available from 1 to 8 inch diameter
Economically advantageous

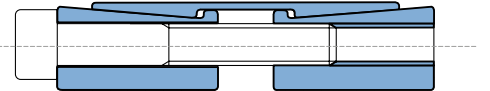

Shrink discs

TLK500
Page 42

Rigid coupling
Medium torque
Available from 14 to 80 mm diameter
Quick installation and dismantling

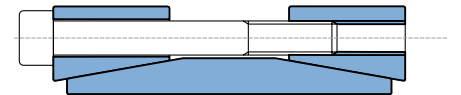

TLK601/602/603
Page 43

Self-centering
High / very high torque
Available from 14 mm to 480 mm diameter
Quick installation

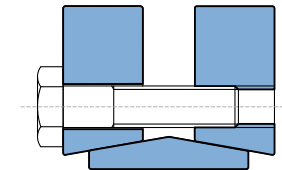

TLK622/623
Page 50

Self-centering
High / very high torque
Available from 12 mm to 620 mm diameter
Quick installation

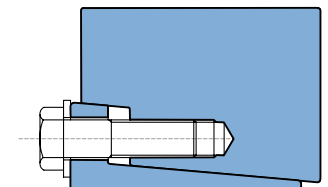

Application examples

Locking assemblies

EA01

Bearing axial fastening and gear locking by means of model TLK 350

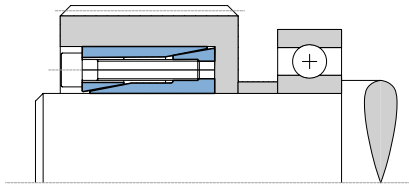

EA02

Chain sprocket locking by means of model TLK 130 with no split outside ring

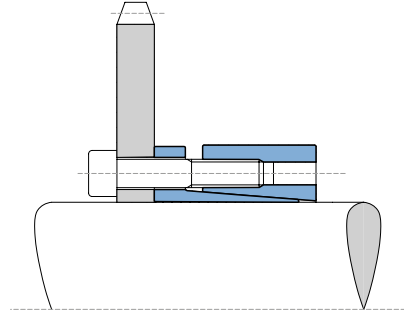

EA03

Thin plate locking by means of model TLK 133 with adapter ring

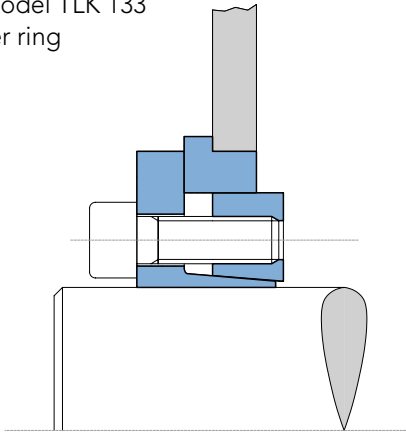

EA04

Break disc locking by means of special model TLK 700

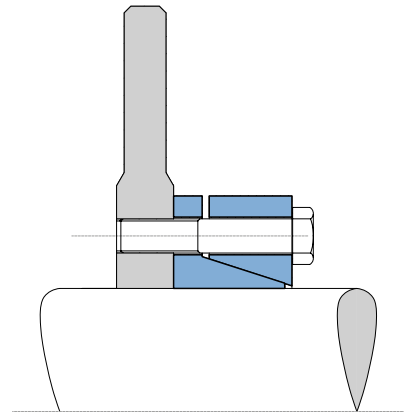

EA05

Hub locking by means of model TLK 200 with a special centering ring

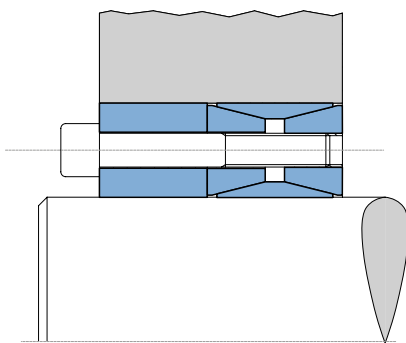

EA06

Large hub locking by means of special version of model TLK 400

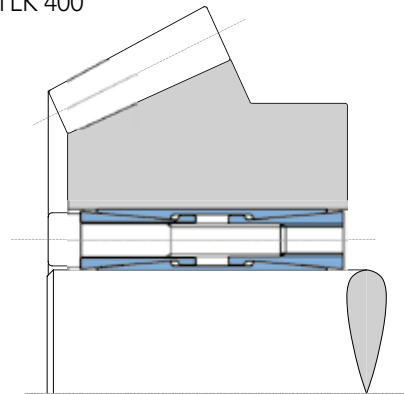

EA07

Cam locking by means of special model TLK 133

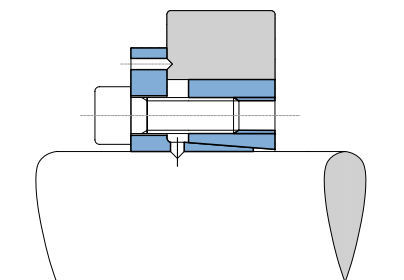

EA08

Use of model TLK 300 without spacer

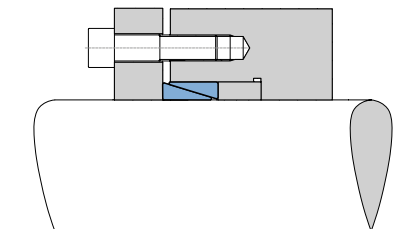

EA09

Use of several locking assemblies in presence of very heavy torque

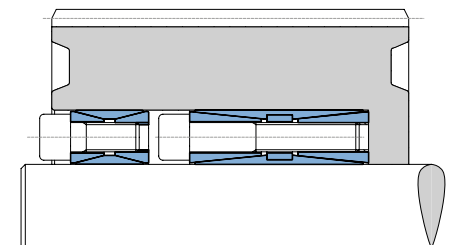

EA10

Use of model TLK 110 in presence of high rpm

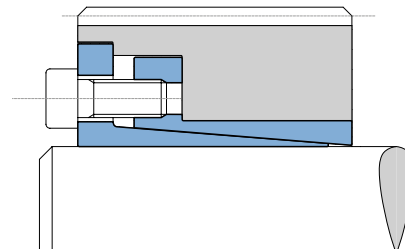

EA11

Special version of model TLK 132 with screws protection ring

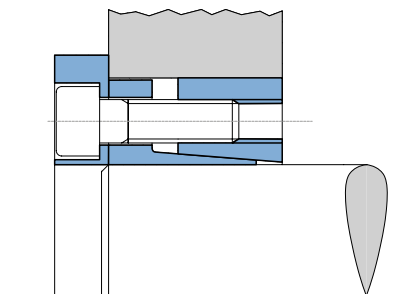

EA12

Special version of model TLK 132 with retaining ring

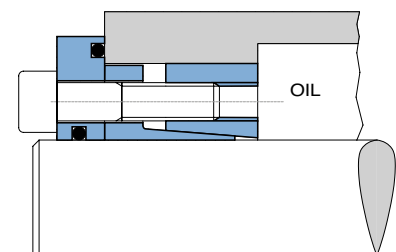

TLK 110

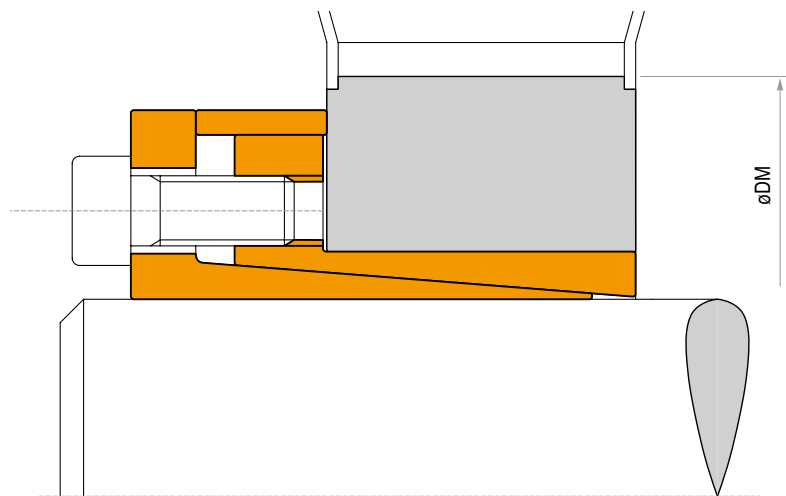

Characteristics

- Medium-high torque
- Restricted hub diameter
- Limited installation time
- Very low surface pressure

Installation

Carefully clean the hub and shaft contact surfaces and apply a thin film of light-weight oil. Slide the locking assembly into the hub bore, insert the shaft and tighten all screws gradually and regularly in crossed sequence to reach the tightening torque M_s as indicated in the rating table.

The values M_t and F_{ax} indicated in the rating table are valid only in case of oil installation. Do not use any oil with **molibdenum bisulphide**, high pressure additives or grease. Above substances notably reduce the coefficient of friction. For additional information on installation refer to page 58.

Dismantling

Loosen the clamping screws. Insert the screws into the dismantling threading and tighten gradually and regularly in crossed sequence until the back cone is released.

If the element is to be reused, relubricate both screws and threadings. For additional information on dismantling refer to page 58.

Tolerances, surface finish

A good surface finish by machine tool is sufficient.
Maximum allowable surface finish:
Rt max 16 μm (Ra 3 μm - Rz 13 μm)

Maximum permissible tolerances:

h8 for shaft
H8 for hub

Axial movement

TLK 110: during screws tightening the hub has no axial movement with respect to the shaft.

DM hub calculation

The pressure P_n in the hub can be compared to the inside pressure on a thick hollow cylinder.

For DM calculation see page 54.

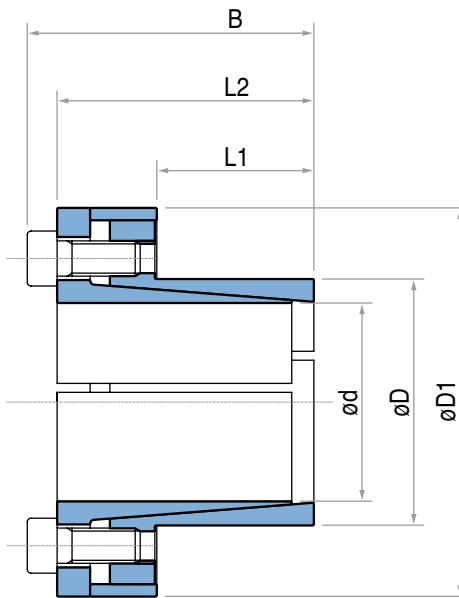

TLK 110 DIMENSIONS

Dimensions								Torque (max.) M _t	Axial Thrust (max.) F _{ax}	Surface pressures on		Tightening screws		Weight (approx.) Lb
d inch	d inch	D inch	L1 inch	L2 inch	L3 inch	B inch	D1 inch			P _s psi	P _h psi	DIN 912 n x type	Tightening torque M _s Lb-ft	
1/4	0.2500	0.551	0.394	0.728	0.827	0.945	0.984	10	950	25598	11610	3 x M3	1.5	0.1
5/16	0.3125	0.591	0.472	0.866	0.984	1.142	1.063	22	1663	29887	15815	3 x M4	4	0.1
3/8	0.3750	0.630	0.551	0.906	1.024	1.181	1.102	35	2218	28463	16945	4 x M4	4	0.1
7/16	0.4375	0.709	0.551	0.906	1.024	1.181	1.260	40	2218	24397	15062	4 x M4	4	0.2
1/2	0.5000	0.906	0.551	0.945	1.181	1.378	1.535	46	2218	21348	11788	4 x M4	4	0.3
5/8	0.6250	0.945	0.630	1.142	1.417	1.654	1.772	99	3835	25837	17090	3 x M6	13	0.5
3/4	0.7500	1.063	0.709	1.220	1.496	1.732	1.929	159	5113	25518	18004	4 x M6	13	0.6
7/8	0.8750	1.260	0.984	1.496	1.772	2.008	2.126	185	5113	15748	10938	4 x M6	13	0.7
15/16	0.9375	1.339	0.984	1.496	1.772	2.008	2.205	198	5113	14698	10294	4 x M6	13	0.8
1	1.0000	1.339	0.984	1.496	1.772	2.008	2.205	211	5113	13780	10294	4 x M6	13	0.9
1 1/8	1.1250	1.535	0.984	1.496	1.772	2.008	2.402	356	7669	18373	13462	6 x M6	13	1
1 3/16	1.1875	1.614	0.984	1.496	1.772	2.008	2.441	376	7669	17406	12805	6 x M6	13	1
1 1/4	1.2500	1.693	0.984	1.496	1.772	2.008	2.559	396	7669	16536	12210	6 x M6	13	1
1 3/8	1.3750	1.850	1.260	1.772	2.047	2.283	2.717	581	10226	15659	11636	8 x M6	13	1
1 7/16	1.4375	1.969	1.260	1.772	2.047	2.283	2.835	606	10226	14978	10938	8 x M6	13	1
1 1/2	1.5000	1.969	1.260	1.772	2.047	2.283	2.835	633	10226	14354	10938	8 x M6	13	2
1 5/8	1.6250	2.165	1.260	1.772	2.047	2.283	3.071	686	10226	13250	9943	8 x M6	13	2
1 11/16	1.6875	2.323	1.772	2.441	2.756	3.071	3.386	1315	18894	16764	12179	8 x M8	30	3
1 3/4	1.7500	2.323	1.772	2.441	2.756	3.071	3.386	1365	18894	16165	12179	8 x M8	30	3
1 7/8	1.8750	2.441	1.772	2.441	2.756	3.071	3.425	1462	18894	15088	11590	8 x M8	30	3
1 15/16	1.9375	2.559	1.772	2.441	2.756	3.071	3.622	1510	18894	14601	11055	8 x M8	30	3
2	2.0000	2.795	2.165	2.835	3.150	3.465	3.858	1754	21256	13020	9315	9 x M8	30	4
2 1/8	2.1250	2.795	2.165	2.835	3.150	3.465	3.858	1864	21256	12254	9315	9 x M8	30	4
2 3/16	2.1875	3.031	2.165	2.835	3.150	3.465	4.094	1918	21256	11904	8590	9 x M8	30	4
2 3/8	2.3750	3.031	2.165	2.835	3.150	3.465	4.094	2082	21256	10964	8590	9 x M8	30	4
2 7/16	2.4375	3.307	2.165	2.835	3.150	3.465	4.370	2138	21256	10683	7874	9 x M8	30	5
2 1/2	2.5000	3.307	2.165	2.835	3.150	3.465	4.370	2192	21256	10416	7874	9 x M8	30	5
2 5/8	2.6250	3.543	2.559	3.386	3.780	4.173	4.685	3655	33750	13328	9873	9 x M10	61	7
2 3/4	2.7500	3.543	2.559	3.386	3.780	4.173	4.685	3829	33750	12722	9873	9 x M10	61	7
2 7/8	2.8750	3.740	2.559	3.386	3.780	4.173	4.961	4003	33750	12169	9354	9 x M10	61	7
2 15/16	2.9375	3.740	2.559	3.386	3.780	4.173	4.961	4090	33750	11910	9354	9 x M10	61	7
3	3.0000	3.740	2.559	3.386	3.780	4.173	4.961	4177	33750	11662	9354	9 x M10	61	7
3 1/8	3.1250	3.937	2.559	3.386	3.780	4.173	5.157	5802	45001	14927	11848	12 x M10	61	8
3 1/4	3.2500	4.173	2.559	3.386	3.780	4.173	5.394	6034	45001	14353	11178	12 x M10	61	8
3 3/8	3.3750	4.173	2.559	3.386	3.780	4.173	5.394	6265	45001	13821	11178	12 x M10	61	8
3 7/16	3.4375	4.409	2.559	3.386	3.780	4.173	5.669	6381	45001	13570	10579	12 x M10	61	9
3 1/2	3.5000	4.409	2.559	3.386	3.780	4.173	5.669	6498	45001	13328	10579	12 x M10	61	9
3 5/8	3.6250	4.409	2.559	3.386	3.780	4.173	5.669	6730	45001	12868	10579	12 x M10	61	9
3 3/4	3.7500	4.724	2.559	3.386	3.780	4.173	5.866	8121	52501	14512	11519	14 x M10	61	10
3 7/8	3.8750	4.921	2.559	3.386	3.780	4.173	6.063	10791	67501	18057	14218	18 x M10	61	10
3 15/16	3.9375	4.921	2.559	3.386	3.780	4.173	6.063	10964	67501	17770	14218	18 x M10	61	11
4	4.0000	4.921	2.559	3.386	3.780	4.173	6.063	11138	67501	17492	14218	18 x M10	61	13
4 1/4	4.2500	5.512	3.543	4.488	5.039	5.512	7.087	11487	65520	11541	8899	12 x M12	107	19
4 3/8	4.3750	5.512	3.543	4.488	5.039	5.512	7.087	11825	65520	11212	8899	12 x M12	107	20
4 7/16	4.4375	6.102	3.543	4.488	5.039	5.512	7.795	11993	65520	11054	8038	12 x M12	107	23
4 1/2	4.5000	6.102	3.543	4.488	5.039	5.512	7.795	12163	65520	10900	8038	12 x M12	107	24
4 3/4	4.7500	6.102	3.543	4.488	5.039	5.512	7.795	12839	65520	10326	8038	12 x M12	107	24
4 15/16	4.9375	6.496	3.543	4.488	5.039	5.512	8.189	17794	87360	13246	10068	16 x M12	107	25

For larger diameter please contact our application engineering department.

TLK 110

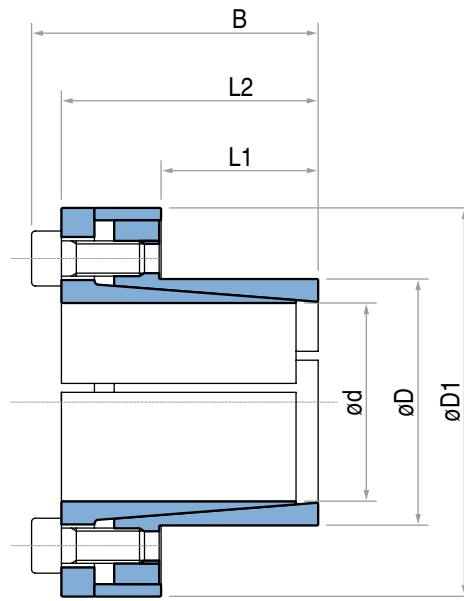

TLK 110 DIMENSIONS

Dimensions								Torque (max.) M _t Lb-ft	Axial Thrust (max.) F _{ax} Lbf	Surface pressures on		Tightening screws		Weight (approx.) Lb
dxD mm	d inch	D inch	L1 inch	L2 inch	L3 inch	B inch	D1 inch			Shaft P _s psi	Hub P _h psi	DIN 912 n x type	Tightening torque M _s Lb-ft	
6 x 14	0.236	0.551	0.394	0.728	0.827	0.945	0.984	9	899	26832	11603	3 x M3	1.5	0.1
7 x 15	0.276	0.591	0.472	0.866	0.984	1.142	1.063	18	1574	34084	15954	3 x M4	4	0.1
8 x 15	0.315	0.591	0.472	0.866	0.984	1.142	1.063	21	1574	29733	15954	3 x M4	4	0.1
9 x 16	0.354	0.630	0.551	0.906	1.024	1.181	1.102	32	2248	29733	16679	4 x M4	4	0.1
10 x 16	0.394	0.630	0.551	0.906	1.024	1.181	1.102	36	2248	26832	16679	4 x M4	4	0.1
11 x 18	0.433	0.709	0.551	0.906	1.024	1.181	1.260	39	2248	24656	15229	4 x M4	4	0.2
12 x 18	0.472	0.709	0.551	0.906	1.024	1.181	1.260	43	2248	23206	15229	4 x M4	4	0.2
13 x 23	0.512	0.906	0.551	0.906	1.024	1.181	1.496	46	2248	20305	11603	4 x M4	4	0.2
14 x 23	0.551	0.906	0.551	0.906	1.024	1.181	1.496	50	2248	18855	11603	4 x M4	4	0.2
*15 x 23	0.591	0.906	0.551	0.945	1.181	1.378	1.535	89	3597	29733	19580	4 x M5	7	0.3
15 x 24	0.591	0.945	0.630	1.142	1.417	1.654	1.772	94	3822	26832	16679	3 x M6	13	0.5
16 x 24	0.630	0.945	0.630	1.142	1.417	1.654	1.772	100	3822	25382	16679	3 x M6	13	0.5
17 x 26	0.669	1.024	0.709	1.220	1.496	1.732	1.850	133	4946	27557	18130	4 x M6	13	0.6
18 x 26	0.709	1.024	0.709	1.220	1.496	1.732	1.850	148	4946	26107	18130	4 x M6	13	0.5
19 x 27	0.748	1.063	0.709	1.220	1.496	1.732	1.929	155	4946	24656	17405	4 x M6	13	0.6
*19 x 28	0.748	1.102	0.709	1.220	1.496	1.693	1.929	111	3597	18130	12328	4 x M5	7	0.6
20 x 28	0.787	1.102	0.709	1.220	1.496	1.732	1.969	162	4946	23206	16679	4 x M6	13	0.6
22 x 32	0.866	1.260	0.984	1.496	1.772	2.008	2.126	184	4946	16679	11603	4 x M6	13	0.7
24 x 34	0.945	1.339	0.984	1.496	1.772	2.008	2.205	199	4946	15229	10878	4 x M6	13	0.8
25 x 34	0.984	1.339	0.984	1.496	1.772	2.008	2.205	207	4946	14504	10878	4 x M6	13	0.8
28 x 39	1.102	1.535	0.984	1.496	1.772	2.008	2.402	343	7419	19580	14069	6 x M6	13	1
30 x 41	1.181	1.614	0.984	1.496	1.772	2.008	2.441	376	7419	18420	13053	6 x M6	13	1
32 x 43	1.260	1.693	0.984	1.496	1.772	2.008	2.559	398	7419	17405	13053	6 x M6	13	1
35 x 47	1.378	1.850	1.260	1.772	2.047	2.283	2.717	583	10116	15229	11603	8 x M6	13	1
38 x 50	1.496	1.969	1.260	1.772	2.047	2.283	2.835	634	10116	14504	10878	8 x M6	13	1
40 x 53	1.575	2.087	1.260	1.772	2.047	2.283	2.953	664	10116	13779	10153	8 x M6	13	1
42 x 55	1.654	2.165	1.260	1.772	2.047	2.283	3.071	701	10116	13053	10153	8 x M6	13	2
45 x 59	1.772	2.323	1.772	2.441	2.756	3.071	3.386	1394	18884	15954	12328	8 x M8	30	3
48 x 62	1.890	2.441	1.772	2.441	2.756	3.071	3.425	1482	18884	15229	11603	8 x M8	30	3
50 x 65	1.969	2.559	1.772	2.441	2.756	3.071	3.622	1549	18884	14504	10878	8 x M8	30	3
55 x 71	2.165	2.795	2.165	2.835	3.150	3.465	3.858	1918	21132	12328	9427	9 x M8	30	4
60 x 77	2.362	3.031	2.165	2.835	3.150	3.465	4.094	2095	21132	10878	8702	9 x M8	30	4
65 x 84	2.559	3.307	2.165	2.835	3.150	3.465	4.370	2264	21132	10153	7977	9 x M8	30	5
70 x 90	2.756	3.543	2.559	3.386	3.780	4.173	4.685	3872	33722	13053	10153	9 x M10	61	7
75 x 95	2.953	3.740	2.559	3.386	3.780	4.173	4.961	4130	33722	11603	9427	9 x M10	61	7
80 x 100	3.150	3.937	2.559	3.386	3.780	4.173	5.157	5915	44962	14504	11603	12 x M10	61	8
85 x 106	3.346	4.173	2.559	3.386	3.780	4.173	5.394	6269	44962	13779	10878	12 x M10	61	8
90 x 112	3.543	4.409	2.559	3.386	3.780	4.173	5.669	6638	44962	13053	10878	12 x M10	61	9
95 x 120	3.740	4.724	2.559	3.386	3.780	4.173	5.866	8113	51706	14504	11603	14 x M10	61	10
100 x 125	3.937	4.921	2.559	3.386	3.780	4.173	6.063	11063	67443	17405	13779	18 x M10	61	10
110 x 140	4.331	5.512	3.543	4.488	5.039	5.512	7.087	11801	65195	11603	9427	12 x M12	107	19
120 x 155	4.724	6.102	3.543	4.488	5.039	5.512	7.795	12907	65195	10153	7977	12 x M12	107	23
130 x 165	5.118	6.496	3.543	4.488	5.039	5.512	8.189	18439	86327	13053	10153	16 x M12	107	25
140 x 180	5.512	7.087	4.331	5.433	6.063	6.614	8.819	34370	166359	18565	14359	14 x M14	170	29

For larger diameter please contact our application engineering department.

* upon request

TLK 111

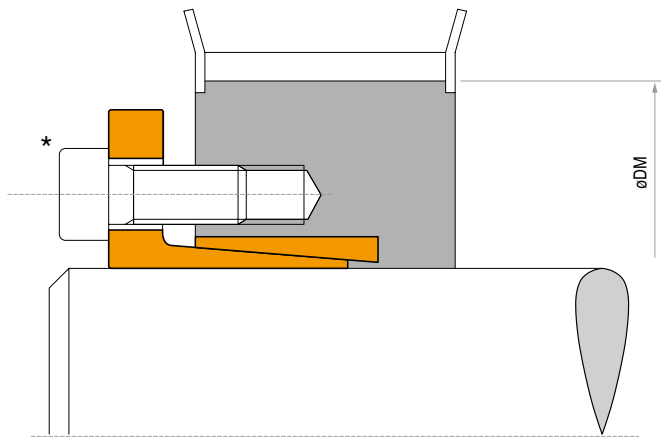

* Upon request.

Characteristics

- Medium torque
- Restricted hub diameter
- Limited installation time
- Very low surface pressure

Installation

Carefully clean the hub and shaft contact surfaces and apply a thin film of light-weight oil. Slide the locking assembly into the hub bore, insert the shaft and the screws (not included in the supply), tighten them gradually and regularly in crossed sequence to reach the tightening torque M_s as indicated in the table.

The values M_t and F_{ax} indicated in the table are valid only in case of screws quality 10.9 or 12.9 and in case of oil installation. Do not use any oil with **molybdenum bisulphide** or high pressure additives and not grease. Above substances notably reduce the friction coefficient.

Dismantling

Loosen the clamping screws. Insert the screws into the dismantling threading and tighten gradually and regularly in crossed sequence until the back cone is released.

If the element is to be reused, relubricate both screws and threadings.

Tolerances, surface finish

A good surface finish by machine tool is sufficient.
Maximum allowable surface finish:
 $R_t \text{ max } 16 \mu\text{m}$ ($R_a \text{ } 3 \mu\text{m}$ - $R_z \text{ } 13 \mu\text{m}$)

Maximum permissible tolerances:

h8 for shaft

H8 for hub

Axial movement

TLK 111: during screws tightening the hub has a slight axial movement with respect to the shaft.

DM hub calculation

The pressure P_n in the hub can be compared to the inside pressure on a thick hollow cylinder.

For DM calculation see page 54.

Locking assembly - Self-centering

TLK 111

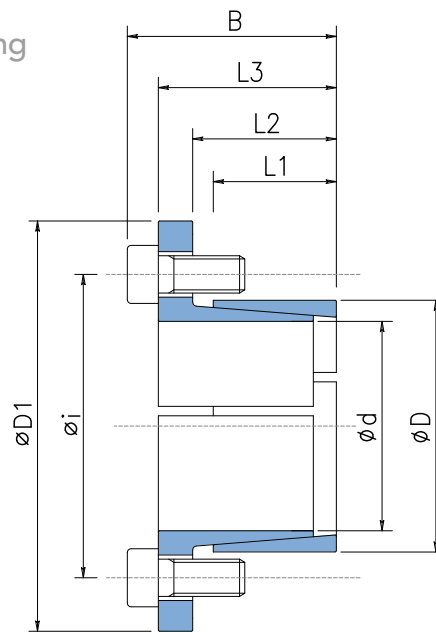

TLK 111 DIMENSIONS

Dimensions								Tightening screws	Screws Class: 10.9					Screws Class: 12.9					Weight
									Tightening torque	Torque	Axial force	Surface pressures on Shaft / Hub		Tightening torque	Torque	Axial force	Surface pressures on Shaft / Hub		
d x D	d	D	L1	L2	L3	D1	i	N° x Type	Ms	Mt	Fax	P _s	P _h	M _t	M _t	Fax	P _s	P _h	Lb
mm	inch	inch	inch	inch	inch	inch	inch		Lb-ft	Lb-ft	Lbf	psi	psi	Lb-ft	Lb-ft	Lbf	psi	psi	
14 x 25	0,5512	0,984	0,630	0,787	1,024	1,654	1,299	4 x M4	3	66	2961	22620	12667	4	81	3558	27186	15224	0,2
15 x 25	0,5906	0,984	0,630	0,787	1,024	1,654	1,299	4 x M4	3	70	2961	21112	12667	4	85	3558	25373	15224	0,2
16 x 25	0,6299	0,984	0,630	0,787	1,024	1,654	1,299	4 x M4	3	77	2961	19793	12667	4	92	3558	23787	15224	0,2
18 x 25	0,7087	0,984	0,630	0,787	1,024	1,654	1,299	4 x M4	3	85	2961	17593	12667	4	103	3558	21144	15224	0,2
19 x 25	0,7480	0,984	0,630	0,787	1,024	1,654	1,299	4 x M4	3	92	2961	16667	12667	4	111	3558	20032	15224	0,2
20 x 30	0,7874	1,181	0,630	0,787	1,024	1,969	1,535	4 x M5	6	159	4862	26003	17335	7	188	5813	31087	20725	0,3
22 x 30	0,8661	1,181	0,630	0,787	1,024	1,969	1,535	4 x M5	6	173	4862	23639	17335	7	207	5813	28261	20725	0,2
24 x 30	0,9449	1,181	0,630	0,787	1,024	1,969	1,535	4 x M5	6	188	4862	21669	17335	7	229	5813	25906	20725	0,2
25 x 36	0,9843	1,417	0,630	0,787	1,024	2,165	1,772	4 x M5	6	199	4862	20802	14446	7	236	5813	24870	17271	0,3
28 x 36	1,1024	1,417	0,630	0,787	1,024	2,165	1,772	4 x M5	6	221	4862	18573	14446	7	266	5813	22205	17271	0,3
30 x 36	1,1811	1,417	0,630	0,787	1,024	2,165	1,772	4 x M5	6	236	4862	17335	14446	7	284	5813	20725	17271	0,3
32 x 42	1,2598	1,654	0,630	0,787	1,102	2,441	2,008	4 x M5	6	254	4862	16252	12382	7	302	5813	19429	14803	0,5
35 x 42	1,3780	1,654	0,630	0,787	1,102	2,441	2,008	4 x M5	6	277	4862	14859	12382	7	332	5813	17764	14803	0,4
36 x 42	1,4173	1,654	0,630	0,787	1,102	2,441	2,008	4 x M5	6	284	4862	14446	12382	7	343	5813	17271	14803	0,4
38 x 44	1,4961	1,732	0,630	0,787	1,102	2,598	2,126	4 x M6	10	424	6845	19267	16640	13	509	8203	23090	19941	0,4
40 x 48	1,5748	1,890	0,630	0,787	1,102	2,756	2,283	4 x M6	10	446	6845	18304	15253	13	535	8203	21935	18279	0,5
42 x 48	1,6535	1,890	0,630	0,787	1,102	2,756	2,283	4 x M6	10	468	6845	17432	15253	13	564	8203	20891	18279	0,4
45 x 55	1,7717	2,165	0,787	0,984	1,378	3,228	2,638	4 x M8	26	929	12604	23966	19608	30	1114	15157	28821	23581	0,9
48 x 55	1,8898	2,165	0,787	0,984	1,378	3,228	2,638	4 x M8	26	988	12604	22468	19608	30	1187	15157	27020	23581	0,7
50 x 62	1,9685	2,441	0,787	0,984	1,378	3,504	2,913	4 x M8	26	1033	12604	21569	17395	30	1239	15157	25939	20918	1,1
55 x 62	2,1654	2,441	0,787	0,984	1,378	3,504	2,913	4 x M8	26	1136	12604	19608	17395	30	1364	15157	23581	20918	0,8
60 x 72	2,3622	2,835	0,787	0,984	1,378	3,898	3,307	4 x M8	26	1239	12604	17974	14979	30	1490	15157	21616	18013	1,2
65 x 72	2,5591	2,835	0,787	0,984	1,378	3,898	3,307	4 x M8	26	1342	12604	16592	14979	30	1615	15157	19953	18013	1,0

For larger diameter please contact our application engineering department.

* upon request

TLK 130

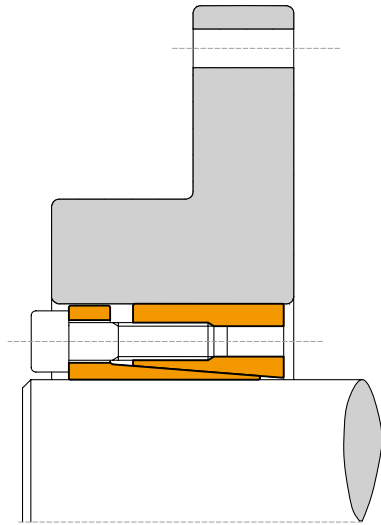

Characteristics

- High torque
- Application economically advantageous
- Quick installation time, low surface pressures
- Excellent shaft-hub perpendicularity

Installation

Carefully clean the hub and shaft contact surfaces and apply a light oil film. Slide the locking assembly into the hub bore, insert the shaft and tighten gradually and regularly incrossed sequence all screws to reach the tightening torque M_s as indicated in the table.

The values M_t and F_{ax} indicated in the table are valid only in case of oil installation. Do not use any oil with **molibdenum bisulphide** or high pressure additives and not grease. Above substances notably reduce the friction coefficient. For additional information on installation refer to page 54.

Dismantling

Loosen the clamping screws. Insert the screws into the dismantling threading and tighten gradually and regularly in crossed sequence until the back cone is released. If the element is to be reused, relubricate both screws and threads. For additional information on dismantling refer to page 58.

TLK 131

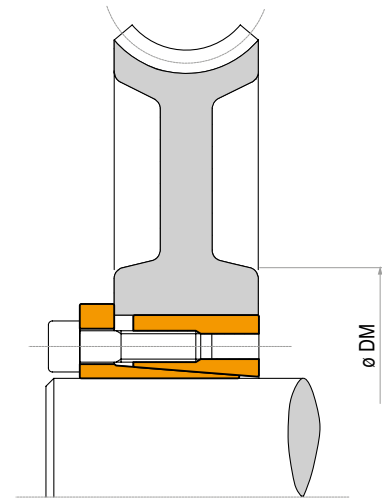

Tolerances, surface finish

A good surface finish by the machine tool is sufficient.
Maximum allowable surface finish:
 R_t max $16 \mu m$ (R_a $3 \mu m$ - R_z $13 \mu m$)

Maximum permissible tolerances:

h8 for shaft

H8 for hub

For exact tolerance values see page 57.

Axial movement

TLK 130: during screws tightening the hub has a slight axial movement with respect to the shaft.

TLK 131: during screws tightening the hub has no axial movement with respect to the shaft.

DM hub calculation

The pressure P_h in the hub can be compared to the inside pressure on a thick hollow cylinder.

For DM calculation see page 54.

TLK 130

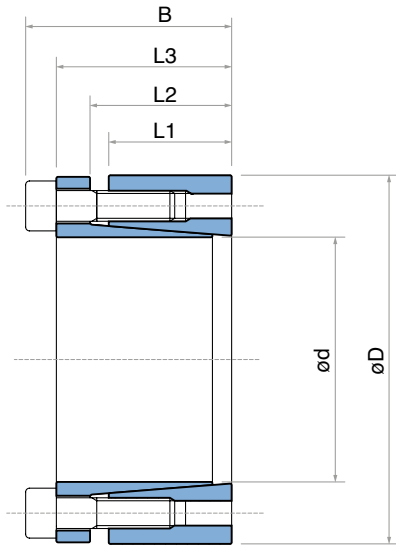

TLK 131

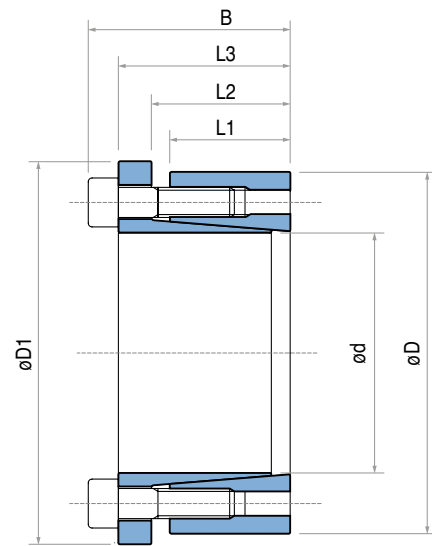

TLK 130 - TLK 131 DIMENSIONS

								TLK 130								TLK 131				
d	d	D	L1	L2	L3	B	D1	Tightening screws		Torque (max.)	Axial Thrust (max.)	Surface pressures on		Weight (approx.)	Torque (max.)	Axial Thrust (max.)	Surface pressures on		Weight (approx.)	
								DIN 912	Tightening torque			Shaft	Hub				Shaft	Hub		
inch	inch	inch	inch	inch	inch	inch	inch	n x type	M _s Lb-ft	M _t Lb-ft	F _{ax} Lbf	P _s psi	P _h psi	Lb	M _t Lb-ft	F _{ax} Lbf	P _s psi	P _h psi	Lb	
3/4	0.7500	1.850	1.024	1.181	1.614	1.850	2.087	6 x M6	13	381	12301	42504	17228	0.9	238	7669	26500	10741	1	
7/8	0.8750	1.850	1.024	1.181	1.614	1.850	2.087	6 x M6	13	444	12301	36432	17228	0.9	278	7669	22714	10741	1	
1	1.0000	1.969	1.024	1.181	1.614	1.850	2.205	6 x M6	13	508	12301	31878	16194	0.9	317	7669	19875	10096	1	
1 1/8	1.1250	2.165	1.024	1.181	1.614	1.850	2.402	6 x M6	13	572	12301	28336	14722	1	356	7669	17666	9179	1	
1 3/16	1.1875	2.165	1.024	1.181	1.614	1.850	2.402	6 x M6	13	603	12301	26845	14722	1	376	7669	16737	9179	1	
1 1/4	1.2500	2.362	1.024	1.181	1.614	1.850	2.598	8 x M6	13	846	16402	34004	17994	1	528	10226	21200	11218	2	
1 3/8	1.3750	2.362	1.024	1.181	1.614	1.850	2.598	8 x M6	13	931	16402	30912	17994	1	581	10226	19272	11218	2	
1 7/16	1.4375	2.559	1.024	1.181	1.614	1.850	2.795	8 x M6	13	973	16402	29568	16609	2	606	10226	18434	10355	2	
1 1/2	1.5000	2.559	1.024	1.181	1.614	1.850	2.795	8 x M6	13	1015	16402	28336	16609	2	633	10226	17666	10355	2	
1 5/8	1.6250	2.953	1.181	1.378	1.929	2.244	3.189	6 x M8	30	1524	22729	31414	17288	2	950	14171	19585	10778	3	
1 11/16	1.6875	2.953	1.181	1.378	1.929	2.244	3.189	6 x M8	30	1583	22729	30250	17288	2	987	14171	18860	10778	3	
1 3/4	1.7500	2.953	1.181	1.378	1.929	2.244	3.189	6 x M8	30	1641	22729	29170	17288	2	1023	14171	18186	10778	3	
1 7/8	1.8750	3.150	1.181	1.378	1.929	2.244	3.386	6 x M8	30	1759	22729	27225	16208	2	1096	14171	16974	10105	3	
1 15/16	1.9375	3.150	1.181	1.378	1.929	2.244	3.386	6 x M8	30	1817	22729	26347	16208	2	1133	14171	16426	10105	3	
2	2.0000	3.150	1.181	1.378	1.929	2.244	3.386	6 x M8	30	1876	22729	25524	16208	2	1170	14171	15913	10105	3	
2 1/8	2.1250	3.346	1.181	1.378	1.929	2.244	3.583	8 x M8	30	2657	30306	32030	20339	3	1657	18894	19969	12680	3	
2 3/16	2.1875	3.346	1.181	1.378	1.929	2.244	3.583	8 x M8	30	2735	30306	31115	20339	3	1705	18894	19399	12680	3	
2 1/4	2.2500	3.543	1.181	1.378	1.929	2.244	3.780	8 x M8	30	2813	30306	30250	19209	3	1754	18894	18860	11976	3	
2 3/8	2.3750	3.543	1.181	1.378	1.929	2.244	3.780	8 x M8	30	2970	30306	28658	19209	3	1852	18894	17867	11976	3	
2 7/16	2.4375	3.740	1.181	1.378	1.929	2.244	4.016	8 x M8	30	3048	30306	27923	18198	3	1900	18894	17409	11346	4	
2 1/2	2.5000	3.740	1.181	1.378	1.929	2.244	4.016	8 x M8	30	3126	30306	27225	18198	3	1949	18894	16974	11346	4	
2 9/16	2.5625	3.740	1.181	1.378	1.929	2.244	4.016	8 x M8	30	3204	30306	26561	18198	4	1997	18894	16560	11346	5	
2 11/16	2.6875	4.331	1.575	1.772	2.323	2.717	4.606	8 x M10	61	5335	48120	30160	18716	5	3326	30000	18803	11669	6	
2 3/4	2.7500	4.331	1.575	1.772	2.323	2.717	4.606	8 x M10	61	5459	48120	29474	18716	5	3404	30000	18376	11669	6	
2 7/8	2.8750	4.528	1.575	1.772	2.323	2.717	4.803	8 x M10	61	5707	48120	28193	17902	6	3559	30000	17577	11161	7	
2 15/16	2.9375	4.528	1.575	1.772	2.323	2.717	4.803	8 x M10	61	5832	48120	27593	17902	6	3636	30000	17203	11161	7	
3	3.0000	4.528	1.575	1.772	2.323	2.717	4.803	8 x M10	61	5955	48120	27018	17902	6	3713	30000	16844	11161	7	
3 1/4	3.2500	4.921	1.575	1.772	2.323	2.717	5.197	10 x M10	61	8064	60149	31175	20588	6	5028	37500	19436	12836	7	
3 3/8	3.3750	4.921	1.575	1.772	2.323	2.717	5.197	10 x M10	61	8374	60149	30020	20588	6	5221	37500	18716	12836	7	
3 7/16	3.4375	5.118	1.575	1.772	2.323	2.717	5.394	10 x M10	61	8529	60149	29474	19796	6	5318	37500	18376	12342	8	
3 1/2	3.5000	5.118	1.575	1.772	2.323	2.717	5.394	10 x M10	61	8685	60149	28948	19796	7	5415	37500	18048	12342	8	
3 3/4	3.7500	5.315	1.575	1.772	2.323	2.717	5.591	10 x M10	61	9305	60149	27018	19063	8	5801	37500	16844	11885	9	
3 15/16	3.9375	5.709	1.811	2.047	2.677	3.150	6.024	8 x M12	107	11380	70061	26062	17976	9	7095	43680	16249	11207	10	
4	4.0000	5.709	1.811	2.047	2.677	3.150	6.024	8 x M12	107	11561	70061	25655	17976	9	7208	43680	15995	11207	11	

NOTE: it is possible to reduce the screws tightening torque down to 60% of the values indicated in the above table; as a result the M_t, F_{ax}, P_s, P_h are reduced proportionally.

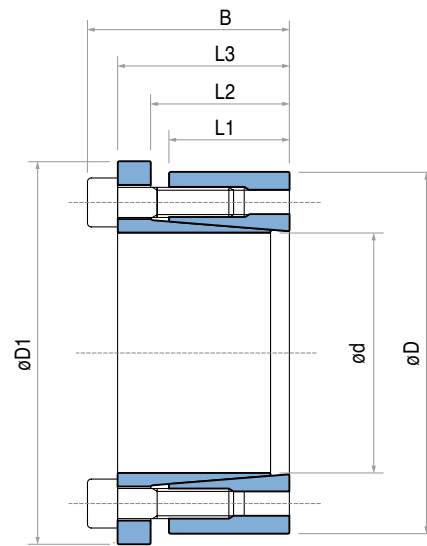
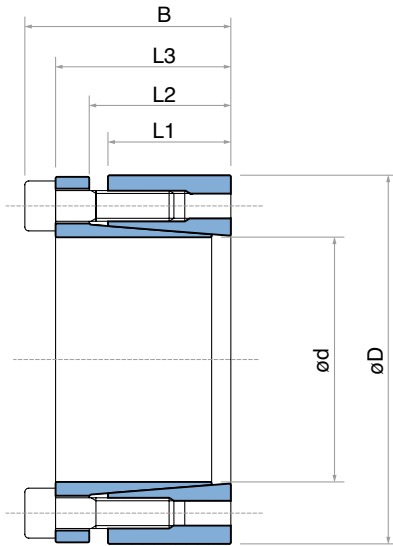

TLK 130 - TLK 131 DIMENSIONS

dxD mm	d inch	D inch	L1 inch	L2 inch	L3 inch	B inch	D1 inch	TLK 130											TLK 131				
								Only TLK 131		Tightening screws		Torque (max.)		Axial Thrust (max.)		Surface pressures on		Weight (approx.) Lb	Torque (max.) Lb-ft	Axial Thrust (max.) Lbf	Surface pressures on		Weight (approx.) Lb
								n	x type	M _s Lb-ft	M _t Lb-ft	F _{ax} Lbf	P _s psi	P _h psi	Shaft	Hub	P _s psi				P _h psi		
20 x 47	0.787	1.850	1.024	1.181	1.614	1.850	2.087	6 x M6	13	398	12140	40611	17405	1	243	7644	25382	10878	1				
22 x 47	0.866	1.850	1.024	1.181	1.614	1.850	2.087	6 x M6	13	443	12140	36985	17405	1	273	7644	23206	10878	1				
24 x 50	0.945	1.969	1.024	1.181	1.614	1.850	2.205	6 x M6	13	479	12140	34084	16679	1	295	7644	21030	10153	1				
25 x 50	0.984	1.969	1.024	1.181	1.614	1.850	2.205	6 x M6	13	502	12140	32633	16679	1	310	7644	20305	10153	1				
28 x 55	1.102	2.165	1.024	1.181	1.614	1.850	2.402	6 x M6	13	561	12140	29008	15229	1	347	7644	18130	9427	1				
30 x 55	1.181	2.165	1.024	1.181	1.614	1.850	2.402	6 x M6	13	605	12140	26832	15229	1	376	7644	16679	9427	1				
32 x 60	1.260	2.362	1.024	1.181	1.614	1.850	2.598	8 x M6	13	856	16411	34084	18130	1	531	10116	21030	11603	2				
35 x 60	1.378	2.362	1.024	1.181	1.614	1.850	2.598	8 x M6	13	937	16411	31183	18130	2	583	10116	19580	11603	2				
38 x 65	1.496	2.559	1.024	1.181	1.614	1.850	2.795	8 x M6	13	1018	16411	29008	16679	1	634	10116	18130	10153	2				
40 x 65	1.575	2.559	1.024	1.181	1.614	1.850	2.795	8 x M6	13	1069	16411	27557	16679	2	664	10116	17405	10153	2				
42 x 75	1.654	2.953	1.181	1.378	1.929	2.244	3.189	6 x M8	30	1571	22706	31183	17405	2	974	14163	19580	10878	3				
45 x 75	1.772	2.953	1.181	1.378	1.929	2.244	3.189	6 x M8	30	1682	22706	29008	17405	3	1040	14163	18130	10878	3				
48 x 80	1.890	3.150	1.181	1.378	1.929	2.244	3.386	6 x M8	30	1792	22706	27557	16679	2	1114	14163	17405	10153	3				
50 x 80	1.969	3.150	1.181	1.378	1.929	2.244	3.386	6 x M8	30	1866	22706	26107	16679	3	1158	14163	15954	10153	3				
55 x 85	2.165	3.346	1.181	1.378	1.929	2.244	3.583	8 x M8	30	2729	30349	31908	20305	2	1704	18884	19580	13053	3				
60 x 90	2.362	3.543	1.181	1.378	1.929	2.244	3.780	8 x M8	30	2950	30349	29008	19580	3	1859	18884	17985	12328	3				
65 x 95	2.559	3.740	1.181	1.378	1.929	2.244	4.016	8 x M8	30	3231	30349	26832	18130	3	2014	18884	16679	11603	3				
70 x 110	2.756	4.331	1.575	1.772	2.323	2.717	4.606	8 x M10	61	5532	48109	29733	18855	5	3430	29900	18130	11603	6				
75 x 115	2.953	4.528	1.575	1.772	2.323	2.717	4.803	8 x M10	61	5900	48109	27557	18130	6	3688	29900	17405	11603	6				
80 x 120	3.150	4.724	1.575	1.772	2.323	2.717	5.000	8 x M10	61	6314	48109	26107	17405	6	3931	29900	15954	10878	6				
85 x 125	3.346	4.921	1.575	1.772	2.323	2.717	5.197	10 x M10	61	8386	60249	30458	21030	6	5222	37543	18855	13053	6				
90 x 130	3.543	5.118	1.575	1.772	2.323	2.717	5.394	10 x M10	61	8851	60249	29008	19580	6	5532	37543	18130	12328	7				
95 x 135	3.740	5.315	1.575	1.772	2.323	2.717	5.591	10 x M10	61	9293	60249	27557	18855	6	5827	37543	16679	12328	7				
100 x 145	3.937	5.709	1.811	2.047	2.677	3.150	6.024	8 x M12	107	11491	70141	26107	18130	9	7154	43613	16679	11603	12				
110 x 155	4.331	6.102	1.811	2.047	2.677	3.150	6.417	8 x M12	107	12612	70141	23931	16679	12	7855	43613	14504	10878	12				
120 x 165	4.724	6.496	1.811	2.047	2.677	3.150	6.811	10 x M12	107	17237	87676	27557	19580	11	10731	54629	17405	12328	12				
130 x 180	5.118	7.087	1.811	2.047	2.677	3.150	7.402	12 x M12	107	22407	104986	30458	21756	11	13977	65420	18855	13779	13				
140 x 190	5.512	7.480	1.969	2.244	2.992	3.543	7.835	8 x M14	170	22053	96219	23931	17405	14	13755	60024	14504	10878	17				
150 x 200	5.906	7.874	1.969	2.244	2.992	3.543	8.228	10 x M14	170	29502	120273	27557	21030	15	18439	74862	17405	13053	17				
160 x 210	6.299	8.268	1.969	2.244	2.992	3.543	8.622	10 x M14	170	31531	120273	26107	19580	15	19656	74862	15954	12328	18				
170 x 225	6.693	8.858	1.969	2.244	2.992	3.543	9.213	12 x M14	170	40197	144103	29008	21756	22	25077	89924	18130	13779	22				
180 x 235	7.087	9.252	1.969	2.244	2.992	3.543	9.606	12 x M14	170	42557	144103	27557	21030	20	26552	89924	17405	13053	22				
190 x 250	7.480	9.843	1.969	2.244	2.992	3.543	10.197	15 x M14	170	56055	179860	32470	24677	21	34665	111238	20244	15385	23				
200 x 260	7.874	10.236	1.969	2.244	2.992	3.543	10.591	15 x M14	170	59005	179860	30847	23728	21	36804	111238	19232	14794	23				
220 x 285	8.661	11.220	2.520	2.835	3.543	4.173	11.575	12 x M16	262	72281	200531	24366	18855	22	44991	124994	15229	11748	24				

For larger diameter please contact our application engineering department.

NOTE: it is possible to reduce the screws tightening torque down to 60% of the values indicated in the above table; as a result the M_t, F_{ax}, P_s, P_n are reduced proportionally.

TLK 132

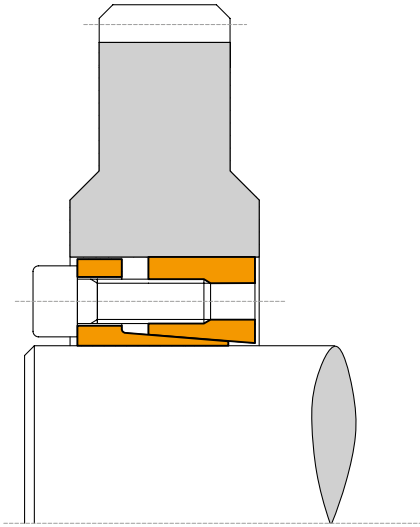

Characteristics

- Medium-high torque
- Application economically advantageous
- Limited installation time
- Interchangeable with TLK 200

Installation

Carefully clean the hub and shaft contact surfaces and apply a light oil film. Slide the locking assembly into the hub bore, insert the shaft and tighten gradually and regularly in crossed sequence all screws to reach the tightening torque M_s as indicated in the table.

The values M_t and F_{ax} indicated in the table are valid only in case of oil installation. Do not use any oil **with molybdenum bisulphide** or high pressure additives and not grease. Above substances notably reduce the friction coefficient. For additional information on installation refer to page 58.

Dismantling

Loosen the clamping screws. Insert the screws into the dismantling threading and tighten gradually and regularly in crossed sequence until the back cone is released. If the element is to be reused, relubricate both screws and threads. For additional information on dismantling refer to page 58.

TLK 133

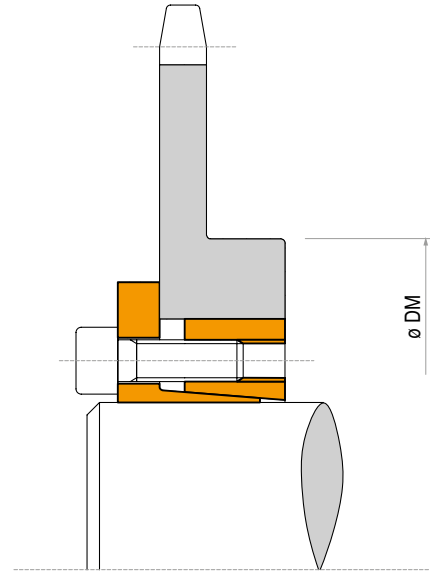

Tolerances, surface finish

A good surface finish by the machine tool is sufficient.
Maximum allowable surface finish:
Rt max 16 μm (Ra 3 μm - Rz 13 μm)

Maximum permissible tolerances:
h8 for shaft
H8 for hub

For exact tolerance values see page 57.

Axial movement

TLK 132: during screws tightening the hub has a slight axial movement with respect to the shaft.

TLK 133: during screws tightening the hub has no axial movement with respect to the shaft.

DM hub calculation

The pressure P_n in the hub can be compared to the inside pressure on a thick hollow cylinder.

For DM calculation see page 54.

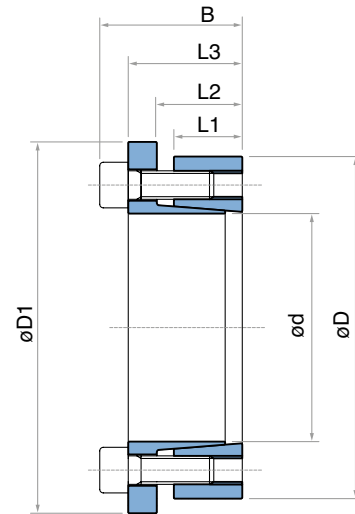
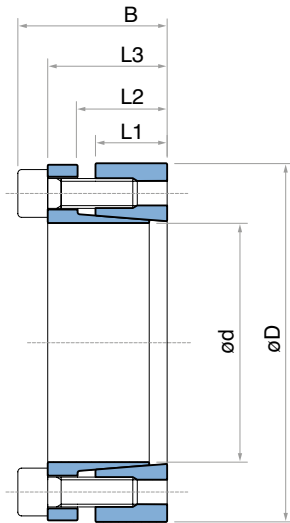

TLK 132 - TLK 133 DIMENSIONS

d	d	D	L1	L2	L3	B	D1	TLK 132										TLK 133				
								n x type	Tightening torque M _s		Torque M _t	Axial F _{ax}	Surface pressures on		Weight	Torque (approx.)	Axial F _{ax}	Surface pressures on		Weight (approx.)		
									DIN 912 12.9	Tightening torque M _s			Shaft Thrust (max.)	Hub				Shaft Thrust (max.)	Hub			
inch	inch	inch	inch	inch	inch	inch	inch	TLK 132	TLK 133	Lb-ft	Lb-ft	Lb-ft	Lbf	psi	psi	Lb	Lb-ft	Lbf	psi	psi	Lb	
3/4	0.7500	1.850	0.669	0.866	1.102	1.339	2.126	5 x M6	10	13	262	8442	44612	18082	1	198	6391	33774	13689	1		
7/8	0.8750	1.850	0.669	0.866	1.102	1.339	2.126	5 x M6	10	13	305	8442	38239	18082	1	231	6391	28949	13689	1		
1	1.0000	1.969	0.669	0.866	1.102	1.339	2.244	6 x M6	10	13	418	10131	40151	20397	1	317	7669	30397	15441	1		
1 1/8	1.1250	2.165	0.669	0.866	1.102	1.339	2.441	6 x M6	10	13	471	10131	35690	18543	1	356	7669	27019	14038	1		
1 3/16	1.1875	2.165	0.669	0.866	1.102	1.339	2.441	6 x M6	10	13	496	10131	33812	18543	1	376	7669	25597	14038	1		
1 1/4	1.2500	2.362	0.669	0.866	1.102	1.339	2.638	8 x M6	10	13	696	13507	42828	22663	1	528	10226	32423	17157	1		
1 3/8	1.3750	2.362	0.669	0.866	1.102	1.339	2.638	8 x M6	10	13	767	13507	38935	22663	1	581	10226	29475	17157	2		
1 7/16	1.4375	2.559	0.669	0.866	1.102	1.339	2.835	8 x M6	10	13	801	13507	37242	20920	1	606	10226	28194	15837	2		
1 1/2	1.5000	2.559	0.669	0.866	1.102	1.339	2.835	8 x M6	10	13	836	13507	35690	20920	1	633	10226	27019	15837	2		
1 5/8	1.6250	2.953	0.787	0.984	1.299	1.614	3.228	7 x M8	26	30	1518	22637	46929	25827	2	1108	16532	34274	18862	2		
1 11/16	1.6875	2.953	0.787	0.984	1.299	1.614	3.228	7 x M8	26	30	1577	22637	45191	25827	2	1151	16532	33005	18862	2		
1 3/4	1.7500	2.953	0.787	0.984	1.299	1.614	3.228	7 x M8	26	30	1635	22637	43577	25827	2	1193	16532	31826	18862	2		
1 7/8	1.8750	3.150	0.787	0.984	1.299	1.614	3.425	7 x M8	26	30	1752	22637	40672	24213	2	1280	16532	29704	17683	2		
1 15/16	1.9375	3.150	0.787	0.984	1.299	1.614	3.425	7 x M8	26	30	1809	22637	39360	24213	2	1322	16532	28746	17683	2		
2	2.0000	3.150	0.787	0.984	1.299	1.614	3.425	7 x M8	26	30	1868	22637	38130	24213	2	1365	16532	27848	17683	3		
2 1/8	2.1250	3.346	0.787	0.984	1.299	1.614	3.622	8 x M8	26	30	2269	25871	41014	26044	2	1657	18894	29954	19021	3		
2 3/16	2.1875	3.346	0.787	0.984	1.299	1.614	3.622	8 x M8	26	30	2335	25871	39842	26044	2	1705	18894	29098	19021	3		
2 1/4	2.2500	3.543	0.787	0.984	1.299	1.614	3.819	8 x M8	26	30	2401	25871	38735	24597	2	1754	18894	28290	17964	3		
2 3/8	2.3750	3.543	0.787	0.984	1.299	1.614	3.819	8 x M8	26	30	2535	25871	36697	24597	2	1852	18894	26801	17964	3		
2 7/16	2.4375	3.740	0.787	0.984	1.299	1.614	4.016	9 x M8	26	30	2927	29104	40225	26215	2	2138	21256	29378	19146	3		
2 1/2	2.5000	3.740	0.787	0.984	1.299	1.614	4.016	9 x M8	26	30	3002	29104	39219	26215	2	2192	21256	28643	19146	3		
2 9/16	2.5625	3.740	0.787	0.984	1.299	1.614	4.016	9 x M8	26	30	3076	29104	38263	26215	2	2248	21256	27945	19146	3		
2 11/16	2.6875	4.331	0.945	1.181	1.575	1.969	4.606	8 x M10	52	61	4499	40583	42393	26308	4	3326	30000	31339	19448	6		
2 3/4	2.7500	4.331	0.945	1.181	1.575	1.969	4.606	8 x M10	52	61	4604	40583	41430	26308	4	3404	30000	30626	19448	6		
2 7/8	2.8750	4.528	0.945	1.181	1.575	1.969	4.803	8 x M10	52	61	4814	40583	39628	25164	4	3559	30000	29295	18602	6		
2 15/16	2.9375	4.528	0.945	1.181	1.575	1.969	4.803	8 x M10	52	61	4918	40583	38785	25164	4	3636	30000	28671	18602	6		
3	3.0000	4.724	0.945	1.181	1.575	1.969	5.000	8 x M10	52	61	5023	40583	37977	24115	4	3713	30000	28074	17827	6		
3 1/4	3.2500	4.921	0.945	1.181	1.575	1.969	5.197	9 x M10	52	61	6122	45656	39438	26045	4	4525	33750	29154	19253	6		
3 3/8	3.3750	4.921	0.945	1.181	1.575	1.969	5.197	9 x M10	52	61	6356	45656	37977	26045	4	4699	33750	28074	19253	6		
3 7/16	3.4375	5.118	0.945	1.181	1.575	1.969	5.394	9 x M10	52	61	6474	45656	37287	25043	5	4786	33750	27564	18513	6		
3 1/2	3.5000	5.118	0.945	1.181	1.575	1.969	5.394	9 x M10	52	61	6592	45656	36621	25043	5	4873	33750	27071	18513	7		
3 3/4	3.7500	5.315	0.945	1.181	1.575	1.969	5.591	10 x M10	52	61	7847	50728	37977	26795	5	5801	37500	28074	19808	7		
3 15/16	3.9375	5.709	1.024	1.260	1.732	2.205	5.984	8 x M12	92	107	9810	60398	39750	27417	6	7095	43680	28748	19828	9		
4	4.0000	5.709	1.024	1.260	1.732	2.205	5.984	8 x M12	92	107	9966	60398	39129	27417	6	7208	43680	28298	19828	9		
4 7/16	4.4375	6.102	1.024	1.260	1.732	2.205	6.378	8 x M12	92	107	11056	60398	35271	25648	7	7996	43680	25508	18549	9		
4 3/4	4.7500	6.496	1.024	1.260	1.732	2.205	6.772	9 x M12	92	107	13314	67947	37070	27106	7	9629	49140	26809	19603	10		
4 15/16	4.9375	7.087	1.339	1.575	2.126	2.598	7.362	12 x M12	92	107	18452	90596	36361	25334	11	13345	65520	26297	18322	15		
5 7/16	5.4375	7.480	1.339	1.575	2.126	2.677	7.756	9 x M14	140	170	20039	89339	32559	23668	11	15124	67425	24573	17862	16		
5 15/16	5.9375	7.874	1.339	1.575	2.126	2.677	8.150	10 x M14	140	170	24313	99265	33130	24982	12	18349	74916	25004	18854	17		
6 7/16	6.4375	8.858	1.732	1.969	2.520	3.071	9.134	12 x M14	140	170	31632	119118	28335	20592	18	23873	89900	21385	15541	25		
6 15/16	6.9375	9.252	1.732	1.969	2.520	3.071	9.528	12 x M14	140	170	34089	119118	26293	19715	18	25728	89900	19843	14879	26		
7 7/16	7.4375	9.843	1.732	1.969	2.520	3.071	10.118	15 x M14	140	170	45682	148898	30656	23166	21	34476	112374	23137	17483	30		
7 15/16	7.9375	10.236	1.732	1.969	2.520	3.071	10.512	15 x M14	140	170	48753	148898	28725	22275	22	36794	112374	21679	16811	31		
8	8.0000	10.236	1.732	1.969	2.52	3.071	10.512	15 x M14	140	170	49137	148898	28501	22275	22	37084	112374	21510	16811	31		

For larger diameter please contact our application engineering department.

NOTE: it is possible to reduce the screws tightening torque down to 60% of the values indicated in the above table; as a result the M_t, F_{ax}, P_s, P_n are reduced proportionally.

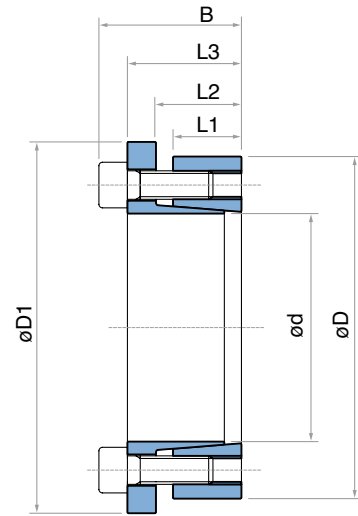
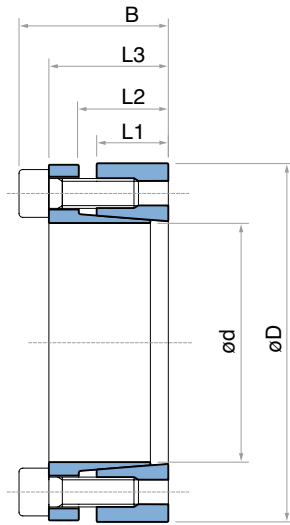

TLK 132 - TLK 133 DIMENSIONS

dxD	d	D	L1	L2	L3	B	D1	Only TLK 133	Tightening screws		TLK 132					TLK 133					
									n x type	TLK 132 Lb-ft	TLK 133 Lb-ft	Torque Lb-ft	Axial (max.) Lbf	Surface pressures on		Weight Lb	Torque (approx.) Lb-ft	Axial (max.) Lbf	Surface pressures on		Weight (approx.) Lb
														Shaft Thrust (max.) psi	Hub psi				Shaft Thrust (max.) psi	Hub psi	
20 x 47	0.787	1.850	0.669	0.866	1.102	1.339	2.126	5 x M6	10	13	280	8543	42786	18130	0.7	207	6295	31908	13779	0.7	
22 x 47	0.866	1.850	0.669	0.866	1.102	1.339	2.126	5 x M6	10	13	302	8543	39160	18130	0.7	221	6295	29008	13779	0.7	
24 x 50	0.945	1.969	0.669	0.866	1.102	1.339	2.244	5 x M6	10	13	332	8543	35534	17405	0.7	243	6295	26107	13053	0.7	
25 x 50	0.984	1.969	0.669	0.866	1.102	1.339	2.244	6 x M6	10	13	420	10341	41336	20305	0.7	310	7644	30458	15229	0.7	
28 x 55	1.102	2.165	0.669	0.866	1.102	1.339	2.441	6 x M6	10	13	465	10341	36985	18855	0.9	347	7644	27557	13779	0.9	
30 x 55	1.181	2.165	0.669	0.866	1.102	1.339	2.441	6 x M6	10	13	487	10341	34084	18855	0.9	369	7644	25382	13779	0.9	
32 x 60	1.260	2.362	0.669	0.866	1.102	1.339	2.638	8 x M6	10	13	715	13489	42786	22481	0.9	531	10116	31908	16679	0.9	
35 x 60	1.378	2.362	0.669	0.866	1.102	1.339	2.638	8 x M6	10	13	782	13489	39160	22481	0.9	583	10116	29008	16679	0.9	
38 x 65	1.496	2.559	0.669	0.866	1.102	1.339	2.835	8 x M6	10	13	848	13489	36259	21030	0.9	627	10116	26832	15229	1	
40 x 65	1.575	2.559	0.669	0.866	1.102	1.339	2.835	8 x M6	10	13	892	13489	34084	21030	0.9	664	10116	25382	15229	1	
42 x 75	1.654	2.953	0.787	0.984	1.299	1.614	3.228	7 x M8	26	30	1512	22031	43511	24656	2	1128	16411	32633	18130	2	
45 x 75	1.772	2.953	0.787	0.984	1.299	1.614	3.228	7 x M8	26	30	1623	22031	42061	24656	2	1217	16411	31183	18130	2	
48 x 80	1.890	3.150	0.787	0.984	1.299	1.614	3.425	7 x M8	26	30	1733	22031	39160	23206	2	1298	16411	29008	17405	2	
50 x 80	1.969	3.150	0.787	0.984	1.299	1.614	3.425	7 x M8	26	30	1807	22031	37710	23206	2	1350	16411	28282	17405	2	
55 x 85	2.165	3.346	0.787	0.984	1.299	1.614	3.622	8 x M8	26	30	2272	25179	39160	25382	2	1696	18659	29008	18855	2	
60 x 90	2.362	3.543	0.787	0.984	1.299	1.614	3.819	8 x M8	26	30	2478	25179	35534	23931	2	1851	18659	26832	18130	2	
65 x 95	2.559	3.740	0.787	0.984	1.299	1.614	4.016	9 x M8	26	30	3017	28326	36985	25382	2	2257	21132	27557	18855	2	
70 x 110	2.756	4.331	0.945	1.181	1.575	1.969	4.606	8 x M10	52	61	4647	40241	40611	26107	4	3444	29900	30458	19580	4	
75 x 115	2.953	4.528	0.945	1.181	1.575	1.969	4.803	8 x M10	52	61	4942	40241	37710	24656	4	3688	29900	28282	18130	4	
80 x 120	3.150	4.724	0.945	1.181	1.575	1.969	5.000	8 x M10	52	61	5274	40241	36259	24656	4	3909	29900	26832	18130	4	
85 x 125	3.346	4.921	0.945	1.181	1.575	1.969	5.197	9 x M10	52	61	6269	44962	37710	26107	4	4647	33272	28282	19580	4	
90 x 130	3.543	5.118	0.945	1.181	1.575	1.969	5.394	9 x M10	52	61	6712	44962	36259	24656	5	4979	33272	26832	18855	5	
95 x 135	3.740	5.315	0.945	1.181	1.575	1.969	5.591	10 x M10	52	61	7818	50357	37710	26107	5	5827	37318	28282	19580	5	
100 x 145	3.937	5.709	1.024	1.260	1.732	2.205	5.984	8 x M12	92	107	9883	60249	39160	27557	6	7154	43613	29008	20305	7	
110 x 155	4.331	6.102	1.024	1.260	1.732	2.205	6.378	8 x M12	92	107	10768	60249	34809	26107	7	7818	43613	26107	18855	7	
120 x 165	4.724	6.496	1.024	1.260	1.732	2.205	6.772	9 x M12	92	107	13202	66993	36259	26107	7	9588	48559	26832	19580	7	
130 x 180	5.118	7.087	1.339	1.575	2.126	2.598	7.362	12 x M12	92	107	19177	89924	34809	24656	11	13940	65195	25382	18130	11	
140 x 190	5.512	7.480	1.339	1.575	2.126	2.677	7.756	9 x M14	140	170	19914	86327	30458	21756	11	15120	65195	23931	17405	12	
150 x 200	5.906	7.874	1.339	1.575	2.126	2.677	8.150	10 x M14	140	170	24339	98916	33359	24656	12	18439	74862	25382	18855	13	
160 x 210	6.299	8.268	1.339	1.575	2.126	2.677	8.543	11 x M14	140	170	28027	107684	33359	24656	13	21389	81381	26107	19580	13	
170 x 225	6.693	8.858	1.732	1.969	2.520	3.071	9.134	12 x M14	140	170	33190	119149	26107	18855	18	25077	89924	20305	15229	18	
180 x 235	7.087	9.252	1.732	1.969	2.520	3.071	9.528	12 x M14	140	170	34665	119149	24656	18855	18	26552	89924	19580	15229	19	
190 x 250	7.480	9.843	1.732	1.969	2.520	3.071	10.118	15 x M14	140	170	46393	148375	30458	21756	21	35034	112405	23206	17405	22	
200 x 260	7.874	10.236	1.732	1.969	2.520	3.071	10.512	15 x M14	140	170	48679	148375	27557	21756	22	36878	112405	21756	16679	23	
220 x 285	8.661	11.220	1.969	2.205	2.835	3.465	11.496	12 x M16	218	262	59742	166584	25962	20015	24	44991	124994	22046	17114	25	

For larger diameter please contact our application engineering department.

NOTE: it is possible to reduce the screws tightening torque down to 60% of the values indicated in the above table; as a result the M_t, F_{ax}, P_s, P_h are reduced proportionally.

TLK 134

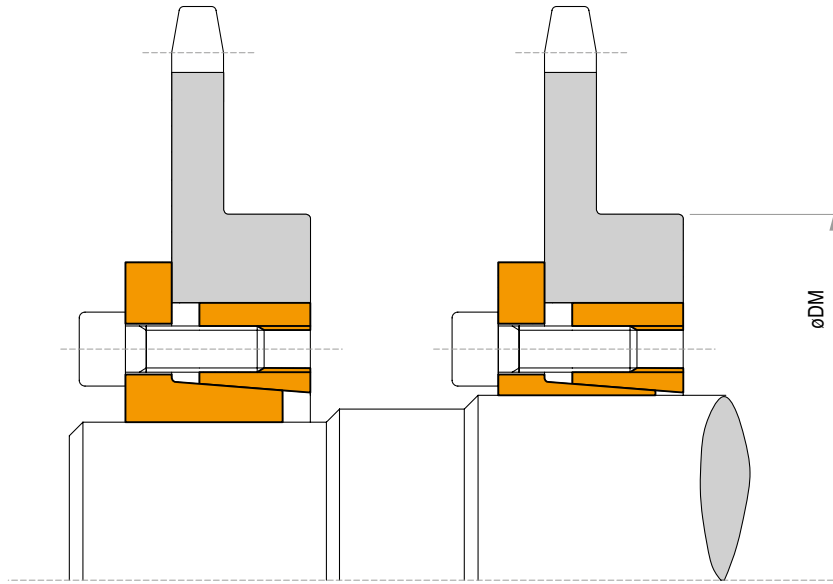

TLK 134 DIMENSIONS

Characteristics

- Medium torque
- Less numbers of screws than TLK133
- Quick installation
- One O.D. and multiple I.D.
- Solution for Sprockets and Pulleys

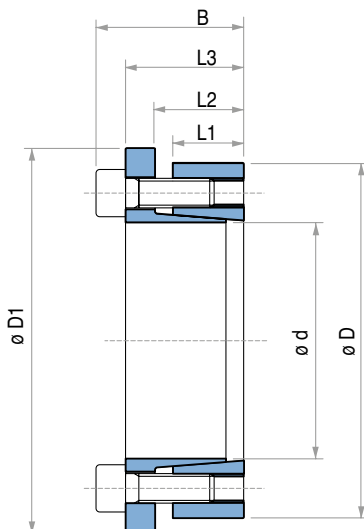

dxD	d	D	L1	L2	L3	B	D1	Torque (max.)	Axial Thrust (max.)	Surface pressures on		Tightening screws		Weight (approx.)
										Shaft	Hub	DIN 912	Tightening Torque	
mm	inch	inch	inch	inch	inch	inch	inch	M _t	F _{ax}	P _s	P _h	12.9	M _s	Lb
14 x 55	0.551	2.165	0.669	0.866	1.181	1.496	2.441	89	4047	29733	7977	3 x M8	18	1
16 x 55	0.630	2.165	0.669	0.866	1.181	1.496	2.441	103	4047	26107	7977	3 x M8	18	1
18 x 55	0.709	2.165	0.669	0.866	1.181	1.496	2.441	111	4047	23206	7977	3 x M8	18	1
19 x 55	0.748	2.165	0.669	0.866	1.181	1.496	2.441	118	4047	21756	7977	3 x M8	18	1
20 x 55	0.787	2.165	0.669	0.866	1.181	1.496	2.441	125	4047	21030	7977	3 x M8	18	1
22 x 55	0.866	2.165	0.669	0.866	1.181	1.496	2.441	207	5620	26832	10878	3 x M8	26	1
24 x 55	0.945	2.165	0.669	0.866	1.181	1.496	2.441	221	5620	24656	10878	3 x M8	26	1
25 x 55	0.984	2.165	0.669	0.866	1.181	1.496	2.441	229	5620	23931	10878	3 x M8	26	1
28 x 55	1.102	2.165	0.669	0.866	1.181	1.496	2.441	317	6969	25382	13053	3 x M8	30	1
30 x 55	1.181	2.165	0.669	0.866	1.181	1.496	2.441	347	6969	23931	13053	3 x M8	30	1
24 x 65	0.945	2.559	0.669	0.866	1.181	1.496	2.835	325	8318	35389	13053	5 x M8	22	1
25 x 65	0.984	2.559	0.669	0.866	1.181	1.496	2.835	339	8318	33939	13053	5 x M8	22	1
28 x 65	1.102	2.559	0.669	0.866	1.181	1.496	2.835	443	9892	35244	15229	5 x M8	26	1
30 x 65	1.181	2.559	0.669	0.866	1.181	1.496	2.835	472	9892	32924	15229	5 x M8	26	1
32 x 65	1.260	2.559	0.669	0.866	1.181	1.496	2.835	509	9892	30893	15229	5 x M8	26	1
35 x 65	1.378	2.559	0.669	0.866	1.181	1.496	2.835	671	11690	33939	18275	5 x M8	30	1
38 x 65	1.496	2.559	0.669	0.866	1.181	1.496	2.835	730	11690	31328	18275	5 x M8	30	1
40 x 65	1.575	2.559	0.669	0.866	1.181	1.496	2.835	774	11690	29733	18275	5 x M8	30	1
30 x 80	1.181	3.150	0.787	0.984	1.299	1.614	3.425	575	11690	33649	12618	7 x M8	22	2
32 x 80	1.260	3.150	0.787	0.984	1.299	1.614	3.425	612	11690	31473	12618	7 x M8	22	2
35 x 80	1.378	3.150	0.787	0.984	1.299	1.614	3.425	782	13713	33649	14794	7 x M8	26	2
38 x 80	1.496	3.150	0.787	0.984	1.299	1.614	3.425	848	13713	31038	14794	7 x M8	26	2
40 x 80	1.575	3.150	0.787	0.984	1.299	1.614	3.425	900	13713	29443	14794	7 x M8	26	2
42 x 80	1.654	3.150	0.787	0.984	1.299	1.614	3.425	1136	16411	33794	17695	7 x M8	30	2
45 x 80	1.772	3.150	0.787	0.984	1.299	1.614	3.425	1217	16411	31473	17695	7 x M8	30	2
48 x 80	1.890	3.150	0.787	0.984	1.299	1.614	3.425	1298	16411	29443	17695	7 x M8	30	2
50 x 80	1.969	3.150	0.787	0.984	1.299	1.614	3.425	1350	16411	28282	17695	7 x M8	30	2

TLK 136

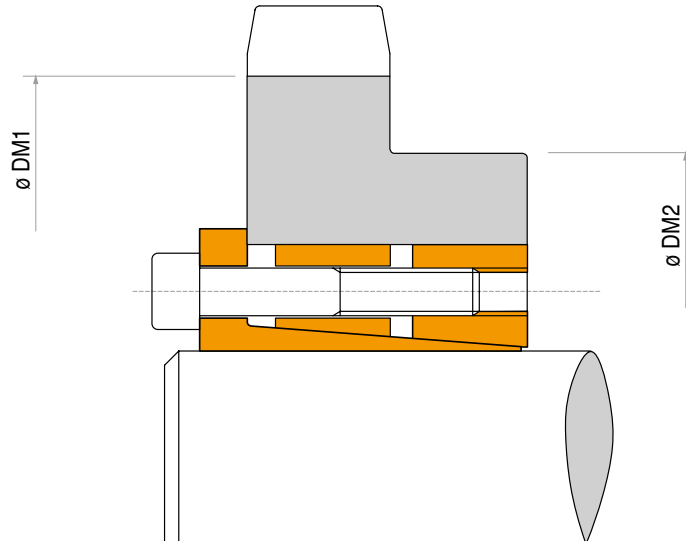

Characteristics

- High torque, high bending moments
- Excellent shaft-hub perpendicularity
- Low surface pressures
- Quick installation time

Installation

Carefully clean the hub and shaft contact surfaces and apply a thin film of light-weight oil. Slide the locking assembly onto shaft, insert them into the hub bore and tighten gradually and regularly in crossed sequence all screws (first the smaller screws, then the bigger ones) to reach the tightening torque M_s as indicated in the table. The values M_t and F_{ax} indicated in the table are valid only in case of oil installation. Do not use any oil with molybdenum bisulphide or high pressure additives and not grease. Above substances notably reduce the friction coefficient.

Dismantling

Loosen the small screws for some turn only and loosen completely the big screws. Insert the big screws into the dismantling threading and tighten gradually and regularly in crossed sequence until the cones are released.

Tolerances, surface finish

A good surface finish by machine tool is sufficient.
Maximum allowable surface finish:
Rt max 16 μm (Ra 3 μm - Rz 13 μm)

Maximum permissible tolerances:
h8 for shaft
H8 for hub

Axial movement

TLK 136: during screws tightening the hub has no axial movement with respect to the shaft.

DM hub calculation

The pressure P_n in the hub can be compared to the inside pressure on a thick hollow cylinder.

For DM calculation see page 54.

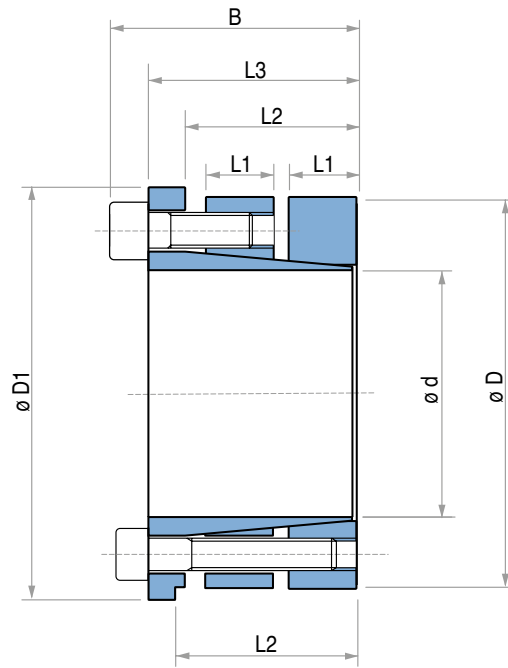

* For diameters > 420 mm.

TLK 136 DIMENSIONS

Dimensions								Torque			Axial force			Surface pressures on				Tightening screws 1		Tightening screws 2		Weight
														Shaft		Hub		DIN912 12.9	Tightening torque	DIN912 12.9	Tightening torque	
d x D mm	d inch	D inch	L1 inch	L2 inch	L3 inch	B inch	D1 inch	M ₁ Lb-Ft	M ₂ Lb-Ft	M _{tot} Lb-Ft	F _{ax1} Lbf	F _{ax2} Lbf	F _{ax tot} Lbf	p _{s1} psi	p _{s2} psi	p _{h1} psi	p _{h2} psi	N° x Type	M _s Lb-Ft	N° x Type	M _s Lb-Ft	Lb
100 x 150	3,9370	5,906	1,024	2,402	3,228	3,780	6,260	8556	6269	14825	172	125	297	34519	25237	23061	16824	7 x M14	170	7 x M12	107	14
110 x 160	4,3307	6,299	1,024	2,402	3,228	3,780	6,654	9441	6859	16300	172	125	297	31473	22916	21611	15809	7 x M14	170	7 x M12	107	15
120 x 170	4,7244	6,693	1,024	2,402	3,228	3,780	7,047	10252	7523	17775	172	125	297	28863	21030	20305	14939	7 x M14	170	7 x M12	107	16
130 x 190	5,1181	7,480	1,181	2,795	3,740	4,370	7,835	17701	12686	30388	273	196	469	36695	26397	25092	18130	8 x M16	262	8 x M14	170	24
140 x 200	5,5118	7,874	1,181	2,795	3,740	4,370	8,228	19103	13719	32822	273	196	469	34084	24511	23786	17114	8 x M16	262	8 x M14	170	26
150 x 210	5,9055	8,268	1,181	2,795	3,740	4,370	8,622	20430	14677	35108	273	196	469	31763	22916	22771	16389	8 x M16	262	8 x M14	170	28
160 x 220	6,2992	8,661	1,181	2,795	3,740	4,370	9,016	21832	15636	37468	273	196	469	29733	21466	21611	15664	8 x M16	262	8 x M14	170	29
170 x 240	6,6929	9,449	1,575	3,622	4,803	5,591	9,803	36214	23159	59374	426	273	699	32779	21030	23206	14939	8 x M20	509	8 x M16	262	47
180 x 250	7,0866	9,843	1,575	3,622	4,803	5,591	10,197	38353	24561	62914	426	273	699	31038	19870	22336	14359	8 x M20	509	8 x M16	262	49
190 x 260	7,4803	10,236	1,575	3,622	4,803	5,591	10,591	40492	25888	66381	426	273	699	29298	18855	21466	13779	8 x M20	509	8 x M16	262	51
200 x 270	7,8740	10,630	1,575	3,622	4,803	5,591	10,984	53252	34149	87401	533	341	874	34809	22336	25817	16534	10 x M20	509	10 x M16	262	54
220 x 290	8,6614	11,417	1,575	3,622	4,803	5,591	11,772	58562	37542	96104	533	341	874	31618	20305	24076	15374	10 x M20	509	10 x M16	262	58
240 x 310	9,4488	12,205	1,575	3,622	4,803	5,591	12,559	76706	49122	125828	639	409	1049	34809	22336	26977	17259	12 x M20	509	12 x M16	262	63
260 x 330	10,2362	12,992	1,575	3,622	4,803	5,591	13,346	83123	53178	163301	639	409	1049	32198	20595	25382	16244	12 x M20	509	12 x M16	262	68
280 x 365	11,0236	14,370	1,772	4,252	5,669	6,614	14,724	107242	74494	181735	766	533	1299	31763	22191	24366	16969	10 x M24	885	10 x M20	509	103
300 x 385	11,8110	15,157	1,772	4,252	5,669	6,614	15,512	114912	79878	194790	766	533	1299	29733	20740	23206	16099	10 x M24	885	10 x M20	509	109
320 x 405	12,5984	15,945	1,772	4,252	5,669	6,614	16,299	147144	102300	249444	920	639	1559	33359	23206	26397	18420	12 x M24	885	12 x M20	509	116
340 x 425	13,3858	16,732	1,772	4,252	5,669	6,614	17,087	182252	126861	309112	1072	746	1819	36695	25527	29298	20450	14 x M24	885	14 x M20	509	121
360 x 445	14,1732	17,520	1,772	4,252	5,669	6,614	17,874	193020	134310	327330	1072	746	1819	34664	24076	27992	19580	14 x M24	885	14 x M20	509	129
380 x 465	14,9606	18,307	1,772	4,252	5,669	6,614	18,661	232848	161969	394817	1226	853	2078	37420	26107	30603	21321	16 x M24	885	16 x M20	509	136
400 x 485	15,7480	19,094	1,772	4,252	5,669	6,614	19,449	245166	170524	415690	1226	853	2078	35679	24801	29443	20450	16 x M24	885	16 x M20	509	142
420 x 505	16,5354	19,882	1,772	4,252	5,669	6,614	20,236	257409	179006	436416	1226	853	2078	33939	23641	28282	19725	16 x M24	885	16 x M20	509	149
440 x 525	17,3228	20,669	2,323	5,787	7,008	7,953	21,024	269653	187562	457215	1226	853	2078	24656	20740	17259	14504	16 x M24	885	16 x M20	509	190
460 x 545	18,1102	21,457	2,323	5,787	7,008	7,953	21,811	281896	196044	477940	1226	853	2078	23641	20015	16534	13924	16 x M24	885	16 x M20	509	197
480 x 565	18,8976	22,244	2,323	5,787	7,008	7,953	22,598	294140	204600	498740	1226	853	2078	22626	19290	15809	13489	16 x M24	885	16 x M20	509	205
500 x 585	19,6850	23,031	2,323	5,787	7,008	7,953	23,386	344810	239855	584665	1379	960	2339	24511	20885	17114	14649	18 x M24	885	18 x M20	509	213
520 x 605	20,4724	23,819	2,323	5,787	7,008	7,953	24,173	358603	249444	608046	1379	960	2339	23496	20305	16389	14069	18 x M24	885	18 x M20	509	220
540 x 625	21,2598	24,606	2,323	5,787	7,008	7,953	24,961	372395	259032	631427	1379	960	2339	22626	19580	15809	13634	18 x M24	885	18 x M20	509	229
560 x 645	22,0472	25,394	2,323	5,787	7,008	7,953	25,748	386188	268620	654808	1379	960	2339	21901	19000	15229	13198	18 x M24	885	18 x M20	509	236
580 x 665	22,8346	26,181	2,323	5,787	7,008	7,953	26,535	444455	309039	753493	1533	1066	2598	23496	20450	16389	14214	20 x M24	885	20 x M20	509	245
600 x 685	23,6220	26,969	2,323	5,787	7,008	7,953	27,323	459796	319733	779529	1533	1066	2598	22626	19870	15809	13779	20 x M24	885	20 x M20	509	251

For other dimensions, please contact us.

TLK 138

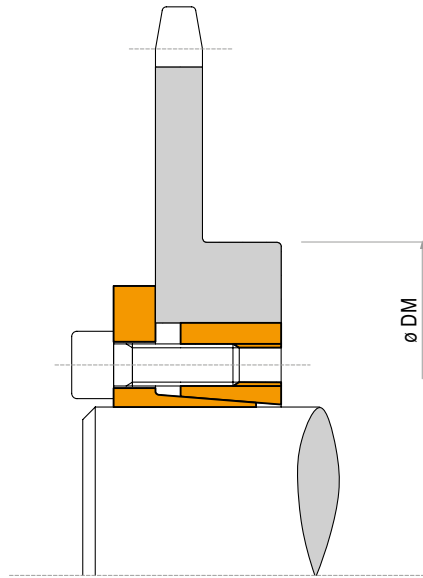

Characteristics

- Medium-low torque
- Quick installation time, compact size
- Application economically advantageous
- Excellent for inch hub i.d.

Carefully clean the hub and shaft contact surfaces and apply a thin film of light-weight oil. Slide the locking assembly into the hub bore, insert the shaft and tighten all screws gradually and regularly in crossed sequence to reach the tightening torque M_s as indicated in the rating table.

The values M_t and F_{ax} indicated in the rating table are valid only in case of oil installation. Do not use any oil with **molibdenum bisulphide**, high pressure additives or grease. Above substances notably reduce the coefficient of friction. For additional information on installation refer to page 58.

Dismantling

Loosen the clamping screws. Insert the screws into the dismantling threading and tighten gradually and regularly in crossed sequence until the back cone is released. If the element is to be reused, relubricate both screws and threadings. For additional information on dismantling refer to page 58.

Tolerances, surface finish

A good surface finish by machine tool is sufficient.
Maximum allowable surface finish:
Rt max 16 μm (Ra 3 μm - Rz 13 μm)

Maximum permissible tolerances:

h8 for shaft
H8 for hub

Axial movement

TLK 138: during screws tightening the hub has no axial movement with respect to the shaft.

DM hub calculation

The pressure P_n in the hub can be compared to the inside pressure on a thick hollow cylinder.

For DM calculation see page 54.

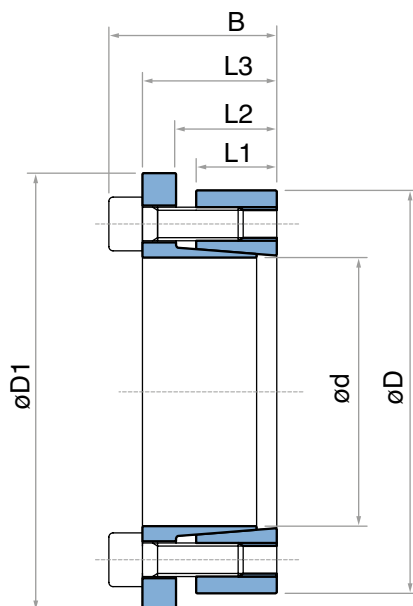

TLK 138 DIMENSIONS

Dimensions								Torque (max.) M_t Lb-ft	Axial Thrust (max.) F_{ax} Lbf	Surface pressures on		Tightening screws		Weight (approx.) Lb
d inch	d inch	D inch	L1 inch	L2 inch	L3 inch	B inch	D1 inch			p_s psi	p_h psi	DIN 912 12.9 n x type	Tightening torque M_s Lb-ft	
1/4	0.2500	0.8125	0.394	0.512	0.650	0.807	0.9375	175	1663	44830	13794	3 x M4	4	0.1
5/16	0.3125	0.8750	0.394	0.512	0.650	0.807	1.0000	263	1663	35864	12809	3 x M4	4	0.1
3/8	0.3750	0.9375	0.394	0.512	0.650	0.807	1.0625	350	1663	29887	11955	3 x M4	4	0.1
1/2	0.5000	1.0625	0.394	0.512	0.650	0.807	1.1875	526	2218	29887	14064	4 x M4	4	0.1
5/8	0.6250	1.1875	0.472	0.591	0.728	0.886	1.3125	1051	3327	29887	15730	6 x M4	4	0.2
3/4	0.7500	1.3125	0.472	0.591	0.728	0.886	1.4375	1227	3327	24906	14232	6 x M4	4	0.2
7/8	0.8750	1.5625	0.591	0.748	0.984	1.181	1.7500	2366	5435	27899	15623	6 x M5	7	0.4
1	1.0000	1.6875	0.591	0.748	0.984	1.181	1.8750	3592	7246	32548	19288	8 x M5	7	0.4
1 1/8	1.1250	1.8750	0.669	0.827	1.063	1.260	2.0000	4556	8152	28719	17231	9 x M5	7	0.6
1 3/16	1.1875	1.9375	0.669	0.827	1.063	1.260	2.0625	5345	9058	30231	18528	10 x M5	7	0.6
1 1/4	1.2500	2.0000	0.669	0.827	1.063	1.260	2.1250	5608	9058	28719	17949	10 x M5	7	0.6
1 3/8	1.3750	2.1250	0.669	0.827	1.063	1.260	2.2500	6134	9058	26108	16894	10 x M5	7	0.6

Dimensions								Torque (max.) M_t Lb-ft	Axial Thrust (max.) F_{ax} Lbf	Surface pressures on		Tightening screws		Weight (approx.) Lb
d mm	d inch	D inch	L1 inch	L2 inch	L3 inch	B inch	D1 inch			p_s psi	p_h psi	DIN 912 12.9 n x type	Tightening torque M_s Lb-ft	
6	0.236	0.8125	0.394	0.512	0.650	0.807	0.9375	175	1663	47445	13794	3 x M4	4	0.1
8	0.315	0.8750	0.394	0.512	0.650	0.807	1.0000	263	1663	35584	12809	3 x M4	4	0.1
10	0.394	0.9375	0.394	0.512	0.650	0.807	1.0625	350	1663	28467	11955	3 x M4	4	0.1
12	0.472	1.0625	0.394	0.512	0.650	0.807	1.1875	526	2218	31630	14064	4 x M4	4	0.1
14	0.551	1.0625	0.394	0.512	0.650	0.807	1.1875	613	2218	27111	14064	4 x M4	4	0.1
15	0.591	1.1875	0.472	0.591	0.787	0.945	1.3125	964	3327	31630	15730	6 x M4	4	0.2
16	0.630	1.1875	0.472	0.591	0.787	0.945	1.3125	1051	3327	29653	15730	6 x M4	4	0.2
19	0.748	1.3125	0.472	0.591	0.787	0.945	1.4375	1227	3327	24971	14232	6 x M4	4	0.2
20	0.787	1.5625	0.591	0.748	0.984	1.181	1.7500	2103	5435	31002	15623	6 x M5	7	0.4
22	0.866	1.5625	0.591	0.748	0.984	1.181	1.7500	2366	5435	28184	15623	6 x M5	7	0.4
24	0.945	1.6875	0.591	0.748	0.984	1.181	1.8750	3417	7246	34447	19288	8 x M5	7	0.4
25	0.984	1.6875	0.591	0.748	0.984	1.181	1.8750	3505	7246	33069	19288	8 x M5	7	0.4
28	1.102	1.8750	0.669	0.827	1.063	1.260	2.0000	4469	8152	29309	17231	9 x M5	7	0.6
30	1.181	1.9375	0.669	0.827	1.063	1.260	2.0625	5257	9058	30394	18528	10 x M5	7	0.6
32	1.260	2.0000	0.669	0.827	1.063	1.260	2.1250	5608	9058	28495	17949	10 x M5	7	0.6
35	1.378	2.1250	0.669	0.827	1.063	1.260	2.2500	6221	9058	26052	16894	10 x M5	7	0.6

TLK 139

TLK 139 DIMENSIONS

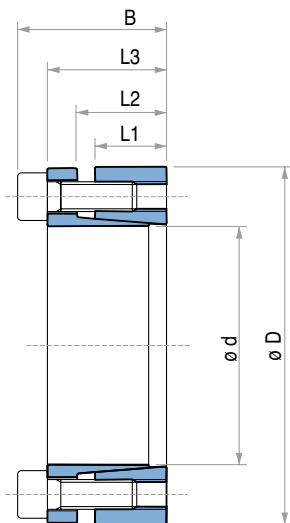

dxD mm	d inch	D inch	L1 inch	L2 inch	L3 inch	B inch	Torque (max.) M _t Lb-ft	Axial Thrust (max.) F _{ax} Lbf	Surface pressures on			Tightening screws	
									Shaft P _s psi	Hub P _h psi	DIN 912 n x type	Tightening Torque Lb-ft	Weight (approx.) Lb
18 x 40	0.709	1.575	0.472	0.591	0.787	0.945	155	5328	33794	19000	6 x M4	4	0.4
19 x 41	0.748	1.614	0.472	0.591	0.787	0.945	162	5328	32053	18565	6 x M4	4	0.4
20 x 42	0.787	1.654	0.472	0.591	0.787	0.945	199	6227	35534	21176	7 x M4	4	0.4
22 x 44	0.866	1.732	0.472	0.591	0.787	0.945	221	6227	32343	20160	7 x M4	4	0.4
24 x 46	0.945	1.811	0.472	0.591	0.787	0.945	243	6227	29588	19290	7 x M4	4	0.4
25 x 47	0.984	1.850	0.472	0.591	0.787	0.945	251	6227	28427	18855	7 x M4	4	0.4
28 x 50	1.102	1.969	0.472	0.591	0.787	0.945	369	8003	32633	22771	9 x M4	4	0.4
30 x 52	1.181	2.047	0.472	0.591	0.787	0.945	391	8003	30458	21901	9 x M4	4	0.4
32 x 54	1.260	2.126	0.472	0.591	0.787	0.945	420	8003	28572	21176	9 x M4	4	0.4
35 x 57	1.378	2.244	0.630	0.748	0.945	1.102	509	8880	22916	16679	10 x M4	4	0.7
36 x 58	1.417	2.283	0.630	0.748	0.945	1.102	524	8880	22191	16389	10 x M4	4	0.7
38 x 60	1.496	2.362	0.630	0.748	0.945	1.102	612	9779	23206	17405	11 x M4	4	0.7
40 x 62	1.575	2.441	0.630	0.748	0.945	1.102	642	9779	22046	16824	11 x M4	4	0.9
42 x 70	1.654	2.756	0.748	0.906	1.181	1.417	1128	16411	29008	21176	8 x M6	13	1
45 x 73	1.772	2.874	0.748	0.906	1.181	1.417	1210	16411	27122	20305	8 x M6	13	1
48 x 76	1.890	2.992	0.748	0.906	1.181	1.417	1291	16411	25382	19435	8 x M6	13	1
50 x 78	1.969	3.071	0.748	0.906	1.181	1.417	1342	16411	24366	19000	8 x M6	13	1
55 x 83	2.165	3.268	0.748	0.906	1.181	1.417	1475	16411	22191	17840	8 x M6	13	2
56 x 84	2.205	3.307	0.748	0.906	1.181	1.417	1505	16411	21756	17550	8 x M6	13	2
60 x 88	2.362	3.465	0.748	0.906	1.181	1.417	1814	18457	22916	18855	9 x M6	13	2
63 x 91	2.480	3.583	0.748	0.906	1.181	1.417	1903	18457	21756	18275	9 x M6	13	2
65 x 93	2.559	3.661	0.748	0.906	1.181	1.417	1962	18457	21176	17840	9 x M6	13	2
70 x 105	2.756	4.134	0.906	1.102	1.457	1.772	3481	30304	26542	21466	8 x M8	30	3
75 x 110	2.953	4.331	0.906	1.102	1.457	1.772	3725	30304	24656	20450	8 x M8	30	3
80 x 115	3.150	4.528	0.906	1.102	1.457	1.772	3975	30304	23206	19580	8 x M8	30	4
85 x 120	3.346	4.724	0.906	1.102	1.457	1.772	4226	30304	21756	18855	8 x M8	30	4
90 x 125	3.543	4.921	0.906	1.102	1.457	1.772	5591	37880	25672	22626	10 x M8	30	5

Characteristics

- Medium-low torque
- Limited installation time
- Application economically advantageous

Installation

Carefully clean the hub and shaft contact surfaces and apply a light oil film. Slide the locking assembly into the hub bore, insert the shaft and tighten gradually and regularly in crossed sequence all screws to reach the tightening torque M_t as indicated in the table.

The values M_t and F_{ax} indicated in the table are valid only in case of oil installation. Do not use any oil with **molibdenum bisulphide** or high pressure additives and not grease. Above substances notably reduce the friction coefficient. For additional information on installation refer to page 58.

Dismantling

Loosen the clamping screws. Insert the screws into the dismantling threading and tighten gradually and regularly in crossed sequence until the back cone is released. If the element is to be reused, relubricate both screws and threadings. For additional information on dismantling refer to page 58.

Tolerances, surface finish

A good surface finish by the machine tool is sufficient. Maximum allowable surface finish:
Rt max 16 μm (Ra 3 μm - Rz 13 μm)

Maximum permissible tolerances:

h8 for shaft
H8 for hub

For exact tolerance values see page 57.

Axial movement

TLK 139: during screws tightening the hub has a slight axial movement with respect to the shaft.

DM hub calculation

The pressure P_h in the hub can be compared to the inside pressure on a thick hollow cylinder.

For DM calculation see page 54.

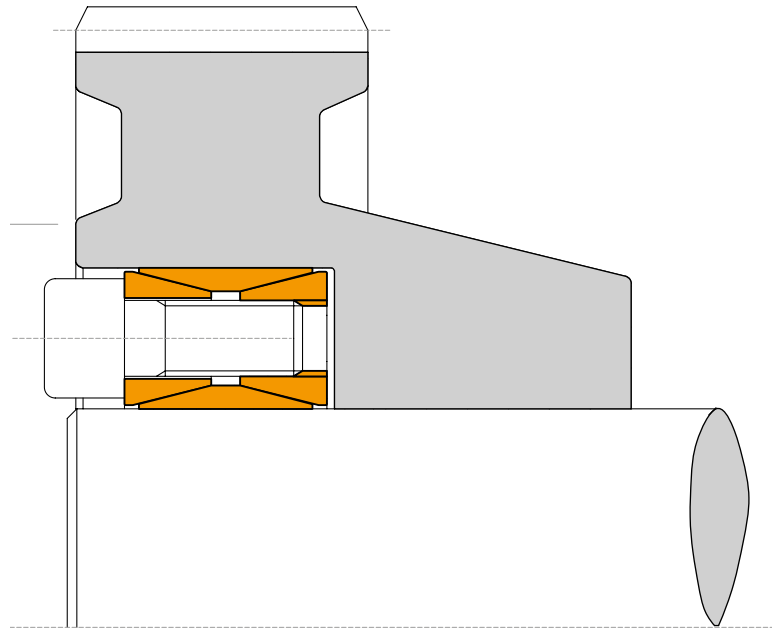

Characteristics

- Medium-high torque
- Wide tolerances
- Compact size
- Easy dismantling

Installation

Carefully clean the hub and shaft contact surfaces and apply a light oil film. Slide the locking assembly into the hub bore and insert the shaft. Tighten cadmium plated clamping screws until inner ring grips the shaft and the outer ring grips the hub bore then tighten gradually and regularly in crossed sequence all screws to reach the tightening torque M_s indicated in the table.

The values M_t and F_{ax} indicated in the table are valid only in case of oil installation. Do not use any oil with **molibdenum bisulphide** or high pressure additives and not grease.

Dismantling

By loosening all tightening screws the clamping unit is normally released. In case of difficulties slightly hammer the released screws to push back the rear pressure cone. For additional information on dismantling refer to page 58.

Tolerances, surface finish

A good surface finish by machine tool is sufficient.
Maximum allowable surface finish:
 R_t max 16 μm (R_a 3 μm - R_z 13 μm)

Maximum permissible tolerances:
h11 for shaft
H11 for hub

Centering

Mod. TLK 200 is not self-centering. The hub concentricity with respect to the shaft depends on the guide surface tolerance and its length.

Axial movement

TLK 200: during screws tightening the hub has no axial movement with respect to the shaft.

DM hub calculation

The pressure P_n in the hub can be compared to the inside pressure on a thick hollow cylinder.

For DM calculation see page 54.

M_t transmissible

If two or more clamping unit are installed together, as a result of carried tests, the M_t transmissible shall be calculated as follow:

Nr. 1 TLK 200	$M_t = M_t \text{ cat.}$
Nr. 2 TLK 200	$M_t = M_t \text{ cat.} \cdot 1,9$
Nr. 3 TLK 200	$M_t = M_t \text{ cat.} \cdot 2,7$

TLK 200 DIMENSIONS

d	d	D	L1	L2	B	M _t	F _{ax}	Surface pressures on		Tightening screws		Weight (approx.)
								Shaft	Hub	DIN 912	Tightening Torque	
inch	inch	inch	inch	inch	inch	Lb-ft	Lbf	psi	psi	n x type	Lb-ft	Lb
3/4	0.7500	1.850	0.669	0.787	1.083	199	6619	34976	14177	8 x M6	11	0.4
7/8	0.8750	1.850	0.669	0.787	1.083	232	6619	29980	14177	8 x M6	11	0.4
1	1.0000	1.969	0.669	0.787	1.083	264	6572	26047	13232	8 x M6	11	0.7
1 1/8	1.1250	2.165	0.669	0.787	1.083	368	8176	28804	14965	10 x M6	11	0.7
1 3/16	1.1875	2.159	0.669	0.787	1.083	388	8157	27223	14973	10 x M6	11	0.7
1 1/4	1.2500	2.362	0.669	0.787	1.083	487	9741	30886	16344	12 x M6	11	0.7
1 3/8	1.3750	2.365	0.669	0.787	1.083	533	9694	27944	16247	12 x M6	11	0.7
1 7/16	1.4375	2.559	0.669	0.787	1.083	647	11242	30996	17411	14 x M6	11	0.9
1 1/2	1.5000	2.559	0.669	0.787	1.083	671	11174	29524	17306	14 x M6	11	0.7
1 5/8	1.6250	2.953	0.787	0.945	1.319	1174	18055	37431	20599	12 x M8	27	1
1 11/16	1.6875	2.953	0.787	0.945	1.319	1215	17989	35912	20524	12 x M8	27	1
1 3/4	1.7500	2.953	0.787	0.945	1.319	1260	17989	34630	20524	12 x M8	27	1
1 7/8	1.8750	3.150	0.787	0.945	1.319	1344	17923	32202	19170	12 x M8	27	1
1 15/16	1.9375	3.150	0.787	0.945	1.319	1386	17878	31086	19123	12 x M8	27	1
2	2.0000	3.346	0.787	0.945	1.319	1663	20781	35004	20920	14 x M8	27	1
2 1/8	2.1250	3.346	0.787	0.945	1.319	1767	20781	32945	20920	14 x M8	27	1
2 3/16	2.1875	3.543	0.787	0.945	1.319	1810	20678	31845	19660	14 x M8	27	2
2 1/4	2.2500	3.543	0.787	0.945	1.319	1862	20678	30960	19660	14 x M8	27	2
2 3/8	2.3750	3.531	0.787	0.945	1.319	1965	20678	29331	19728	14 x M8	27	2
2 7/16	2.4375	3.740	0.787	0.945	1.319	2296	23544	32540	21206	16 x M8	27	2
2 1/2	2.5000	3.740	0.787	0.945	1.319	2355	23544	31726	21206	16 x M8	27	2
2 9/16	2.5625	3.737	0.787	0.945	1.319	2414	23544	30952	21224	16 x M8	27	2
2 5/8	2.6250	4.331	0.945	1.102	1.555	3186	30340	32448	19668	14 x M10	52	3
2 11/16	2.6875	4.331	0.945	1.102	1.555	3262	30340	31693	19668	14 x M10	52	3
2 3/4	2.7500	4.337	0.945	1.102	1.555	3337	30340	30973	19639	14 x M10	52	3
2 7/8	2.8750	4.528	0.945	1.102	1.555	3472	30187	29477	18718	14 x M10	52	3
2 15/16	2.9375	4.528	0.945	1.102	1.555	3548	30187	28850	18718	14 x M10	52	3
3	3.0100	4.724	0.945	1.102	1.555	3604	30034	28106	17847	14 x M10	52	3
3 1/8	3.1250	4.724	0.945	1.102	1.555	3755	30034	26982	17847	14 x M10	52	3
3 1/4	3.2500	4.921	0.945	1.102	1.555	4445	34194	29537	19506	16 x M10	52	3
3 3/8	3.3750	4.921	0.945	1.102	1.555	4617	34194	28443	19506	16 x M10	52	3
3 7/16	3.4375	5.118	0.945	1.102	1.555	4684	34063	27819	18684	16 x M10	52	3
3 1/2	3.5000	5.118	0.945	1.102	1.555	4770	34063	27322	18684	16 x M10	52	3
3 5/8	3.6250	5.315	0.945	1.102	1.555	5536	38173	29563	20163	18 x M10	52	4
3 3/4	3.7500	5.305	0.945	1.102	1.555	5727	38173	28578	20201	18 x M10	52	4
3 7/8	3.8750	5.709	1.024	1.299	1.850	6923	44663	29868	20275	14 x M12	94	5
3 15/16	3.9375	5.709	1.024	1.299	1.850	7035	44663	29394	20275	14 x M12	94	5
4	4.0000	5.843	1.024	1.299	1.850	7147	44663	28935	19809	14 x M12	94	5
4 1/8	4.1250	6.102	1.024	1.299	1.850	7322	44374	27877	18844	14 x M12	94	6
4 3/16	4.1880	6.102	1.024	1.299	1.850	7434	44374	27457	18844	14 x M12	94	6
4 1/4	4.2500	6.102	1.024	1.299	1.850	7544	44374	27057	18844	14 x M12	94	6
4 7/16	4.4375	6.496	1.024	1.299	1.850	9002	50713	29616	20231	16 x M12	94	6
4 1/2	4.5000	6.496	1.024	1.299	1.850	9129	50713	29204	20231	16 x M12	94	6
4 3/4	4.7500	6.496	1.024	1.299	1.850	9636	50713	27667	20231	16 x M12	94	6
4 15/16	4.9375	7.087	1.339	1.496	2.047	12455	63061	25310	17634	20 x M12	94	8
5	5.0000	7.087	1.339	1.496	2.047	12613	63061	24993	17634	20 x M12	94	8
5 7/16	5.4375	7.480	1.339	1.496	2.047	15028	69095	25181	18305	22 x M12	94	9
5 1/2	5.5000	7.492	1.339	1.496	2.047	15201	69095	24895	18276	22 x M12	94	9
5 3/4	5.7500	7.874	1.339	1.496	2.047	17337	75376	25978	18970	24 x M12	94	9
6	6.0000	8.268	1.339	1.496	2.047	19444	81014	26757	19418	26 x M12	94	9
6 7/16	6.4375	8.858	1.496	1.732	2.362	23383	90805	25010	18176	22 x M14	144	13
6 1/2	6.5000	8.858	1.496	1.732	2.362	23610	90805	24770	18176	22 x M14	144	13
6 15/16	6.9375	9.252	1.496	1.732	2.362	27380	98665	25217	18909	24 x M14	144	13
7	7.0000	9.252	1.496	1.732	2.362	27626	98665	24992	18909	24 x M14	144	13
7 1/2	7.5000	9.823	1.811	2.047	2.677	34441	114803	22420	17119	28 x M14	144	19
7 7/8	7.8750	10.236	1.811	2.047	2.677	38592	122510	22786	17530	30 x M14	144	19
8	8.0000	10.504	1.811	2.047	2.677	39204	122510	22430	17083	30 x M14	144	19

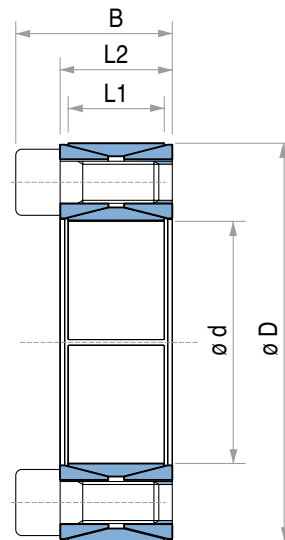

For larger diameter please contact our application engineering department.

TLK 200 DIMENSIONS

dxD	d	D	L1	L2	B	M _t	F _{ax}	Surface pressures on		Tightening screws		Weight (approx.)
								Shaft	Hub	DIN 912	Tightening Torque	
mm	inch	inch	inch	inch	inch	Lb-ft	Lbf	psi	psi	12.9 n x type	M _s Lb-ft	Lb
19 x 47	0.748	1.850	0.669	0.787	1.083	199	6519	32633	13779	8 x M6	11	0.4
20 x 47	0.787	1.850	0.669	0.787	1.083	207	6519	32633	13779	8 x M6	11	0.4
22 x 47	0.866	1.850	0.669	0.787	1.083	229	6519	30458	13779	8 x M6	11	0.4
24 x 50	0.945	1.969	0.669	0.787	1.083	273	7194	30458	14504	8 x M6	11	0.7
25 x 50	0.984	1.969	0.669	0.787	1.083	295	7194	29008	14504	8 x M6	11	0.7
28 x 55	1.102	2.165	0.669	0.787	1.083	369	8093	29008	14504	10 x M6	11	0.7
30 x 55	1.181	2.165	0.669	0.787	1.083	391	8093	26832	14504	10 x M6	11	0.7
32 x 60	1.260	2.362	0.669	0.787	1.083	502	9442	29733	15954	12 x M6	11	0.7
35 x 60	1.378	2.362	0.669	0.787	1.083	553	9667	27557	15954	12 x M6	11	0.7
38 x 65	1.496	2.559	0.669	0.787	1.083	686	11016	29008	16679	14 x M6	11	0.9
40 x 65	1.575	2.559	0.669	0.787	1.083	723	11016	27557	16679	14 x M6	11	0.7
42 x 75	1.654	2.953	0.787	0.945	1.319	1165	16861	34084	18855	12 x M8	27	1
45 x 75	1.772	2.953	0.787	0.945	1.319	1254	17086	31908	18855	12 x M8	27	1
48 x 80	1.890	3.150	0.787	0.945	1.319	1320	16636	30458	17405	12 x M8	27	1
50 x 80	1.969	3.150	0.787	0.945	1.319	1379	16861	29008	17405	12 x M8	27	1
55 x 85	2.165	3.346	0.787	0.945	1.319	1763	19783	30458	19580	14 x M8	27	1
60 x 90	2.362	3.543	0.787	0.945	1.319	1925	19783	27557	18130	14 x M8	27	2
65 x 95	2.559	3.740	0.787	0.945	1.319	2368	22031	29008	19580	16 x M8	27	2
70 x 110	2.756	4.331	0.945	1.102	1.555	3393	29675	30458	18855	14 x M10	52	3
75 x 115	2.953	4.528	0.945	1.102	1.555	3614	29450	28282	18130	14 x M10	52	3
80 x 120	3.150	4.724	0.945	1.102	1.555	3835	29450	26107	17405	14 x M10	52	3
85 x 125	3.346	4.921	0.945	1.102	1.555	4647	33272	28282	18855	16 x M10	52	3
90 x 130	3.543	5.118	0.945	1.102	1.555	4868	33047	26107	18130	16 x M10	52	3
95 x 135	3.740	5.315	0.945	1.102	1.555	5827	37543	28282	19580	18 x M10	52	4
100 x 145	3.937	5.709	1.024	1.299	1.850	7191	43838	28282	19580	14 x M12	94	5
110 x 155	4.331	6.102	1.024	1.299	1.850	7855	43613	26107	18130	14 x M12	94	6
120 x 165	4.724	6.496	1.024	1.299	1.850	9810	49683	26832	19580	16 x M12	94	6
130 x 180	5.118	7.087	1.339	1.496	2.047	13165	62048	23931	16679	20 x M12	94	8
140 x 190	5.512	7.480	1.339	1.496	2.047	15636	67893	23931	18130	22 x M12	94	9
150 x 200	5.906	7.874	1.339	1.496	2.047	18070	73962	24656	18130	24 x M12	94	9
160 x 210	6.299	8.268	1.339	1.496	2.047	20947	79808	24656	18855	26 x M12	94	9
170 x 225	6.693	8.858	1.496	1.732	2.362	24782	89025	23931	17405	22 x M14	144	13
180 x 235	7.087	9.252	1.496	1.732	2.362	28544	96893	24656	18855	24 x M14	144	13
190 x 250	7.480	9.843	1.811	2.047	2.677	32969	112855	22481	17405	28 x M14	144	19
200 x 260	7.874	10.236	1.811	2.047	2.677	39459	120948	22481	17405	30 x M14	144	19
220 x 285	8.661	11.220	1.969	2.205	2.913	50523	141630	22481	17405	26 x M16	221	24
230 x 295	9.055	11.614	1.969	2.205	2.913	60808	161189	24656	19580	30 x M16	221	25
240 x 305	9.449	12.008	1.969	2.205	2.913	63430	161189	23931	18855	30 x M16	221	26
260 x 325	10.236	12.795	1.969	2.205	2.913	77444	182096	23931	19580	34 x M16	221	29
280 x 355	11.024	13.976	2.362	2.598	3.406	94776	206825	21756	17405	32 x M18	302	42
300 x 375	11.811	14.764	2.362	2.598	3.406	113289	230430	22481	18130	36 x M18	302	44
320 x 405	12.598	15.945	2.835	3.071	3.957	155256	297873	22481	18130	36 x M20	435	66
340 x 425	13.386	16.732	2.835	3.071	3.957	165951	297873	21756	17405	36 x M20	435	66
360 x 455	14.173	17.913	3.307	3.543	4.567	217359	367564	21756	17405	36 x M22	583	93
380 x 475	14.961	18.701	3.307	3.543	4.567	227980	365316	20305	17405	36 x M22	583	97
400 x 495	15.748	19.488	3.307	3.543	4.567	237421	363518	19580	15954	36 x M22	583	101
420 x 515	16.535	20.276	3.307	3.543	4.567	275847	400162	19580	15954	40 x M22	583	110
440 x 545	17.323	21.457	3.780	4.016	5.118	335590	463109	18855	15229	40 x M24	738	143
460 x 565	18.110	22.244	3.780	4.016	5.118	346653	458612	18130	14504	40 x M24	738	148
480 x 585	18.898	23.031	3.780	4.016	5.118	379843	485590	18130	14504	42 x M24	738	157
500 x 605	19.685	23.819	3.780	4.016	5.118	413034	503574	18130	14504	44 x M24	738	161
520 x 630	20.472	24.803	3.780	4.016	5.118	442536	521559	18130	14504	45 x M24	738	176
540 x 650	21.260	25.591	3.780	4.016	5.118	464663	526055	17405	14504	45 x M24	738	181
560 x 670	22.047	26.378	3.780	4.016	5.118	501541	548536	17405	14504	48 x M24	738	187
580 x 690	22.835	27.165	3.780	4.016	5.118	542107	571017	17405	14504	50 x M24	738	194
600 x 710	23.622	27.953	3.780	4.016	5.118	571609	580010	17405	14504	50 x M24	738	201
620 x 730	24.409	28.740	3.780	4.016	5.118	608487	597995	17405	14504	52 x M24	738	205
640 x 750	25.197	29.528	3.780	4.016	5.118	637989	606987	16679	14504	54 x M24	738	212
660 x 770	25.984	30.315	3.780	4.016	5.118	682243	629468	17405	14504	56 x M24	738	218
680 x 790	26.772	31.102	3.780	4.016	5.118	711745	638460	16679	14504	56 x M24	738	225
700 x 810	27.559	31.890	3.780	4.016	5.118	759687	665438	16679	14504	60 x M24	738	229
720 x 830	28.346	32.677	3.780	4.016	5.118	789189	669934	16679	14504	60 x M24	738	236
740 x 850	29.134	33.465	3.780	4.016	5.118	840818	692415	16679	14504	62 x M24	738	243
760 x 870	29.921	34.252	3.780	4.016	5.118	892448	714896	16679	14504	64 x M24	738	249
780 x 890	30.709	35.039	3.780	4.016	5.118	921950	723888	16679	14504	65 x M24	738	256
800 x 910	31.496	35.827	3.780	4.016	5.118	958828	732881	16679	14504	66 x M24	738	260
820 x 930	32.283	36.614	3.780	4.016	5.118	1010457	750865	16679	14504	68 x M24	738	267
840 x 950	33.071	37.402	3.780	4.016	5.118	1069462	777843	16679	14504	70 x M24	738	273
860 x 970	33.858	38.189	3.780	4.016	5.118	1121091	795827	16679	14504	72 x M24	738	280
880 x 990	34.646	38.976	3.780	4.016	5.118	1172720	813812	16679	14504	74 x M24	738	284
900 x 1010	35.433	39.764	3.780	4.016	5.118	1216974	827301	16679	14504	75 x M24	738	291

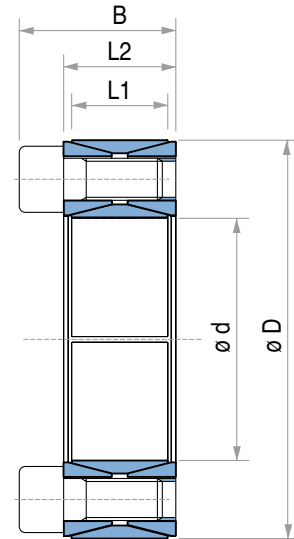

For larger diameter please contact our application engineering department.

Locking assembly - Not self-centering

TLK 250

Locking assembly - Self-centering

TLK 250 L

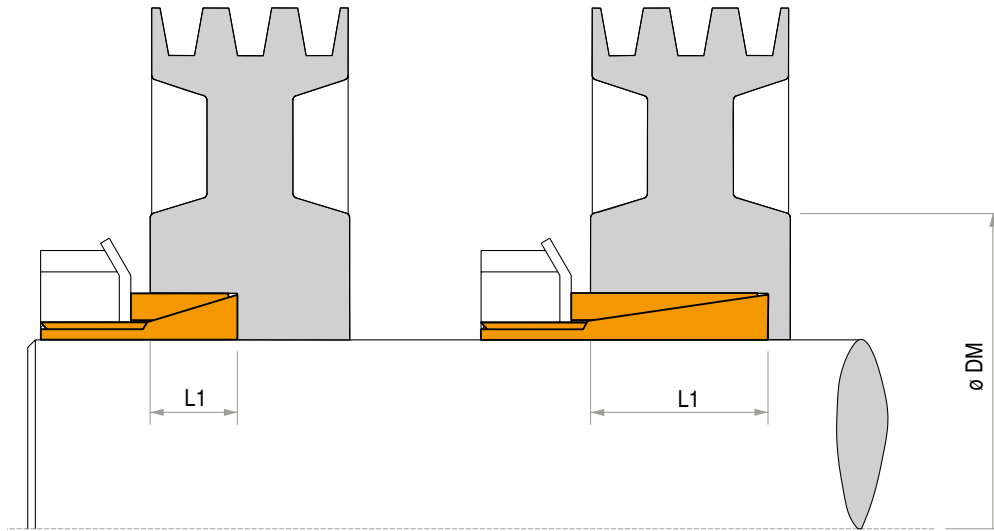

Characteristics

- Medium-low torque
- Small hub diameter
- Quick installation time
- Application economically advantageous

Installation

Carefully clean the hub and shaft contact surfaces and apply a light oil film. Slide the locking assembly into the hub bore, insert the shaft and tighten the nut at tightening torque M_s as indicated in the table and fold down the security washer tooth if fitted. The values M_t and F_{ax} indicated in the table are valid only in case of oil installation.

Do not use any oil with **molybdenum bisulphide** or high pressure additives and not grease. Above substances notably reduce the friction coefficient.

Dismantling

Loosen the tightening collar. As the cone angle of TLK 250 is about 17° , the unit is self releasing.

Tolerances, surface finish

A good surface finish by the machine tool is sufficient.
Maximum allowable surface finish:
Rt max $16 \mu\text{m}$ (Ra $3 \mu\text{m}$ - Rz $13 \mu\text{m}$)

Maximum permissible tolerances:
h8 for shaft
H8 for hub

For exact tolerance values see page 57.

Axial movement

TLK 250 and TLK 250L: during tightening of mounting nut the hub has a slight axial movement with respect to the shaft.

DM hub calculation

The pressure P_h in the hub can be compared to the inside pressure on a thick hollow cylinder.

For DM calculation see page 54.

TLK 250 DIMENSIONS

dxD	d	D	B	L1	D1	Torque (max.)	Axial Thrust (max.)	Surface pressures on		Tightening screws			Weight (approx.)
								Shaft	Hub	DIN 912	Tightening Torque	Nut Size	
mm	inch	inch	inch	inch	inch	M _t Lb-ft	F _{ax} Lbf	P _s psi	P _h psi	Nut Size	M _s Lb-ft	Lb	
14 x 25	0.551	0.984	0.650	0.256	1.260	28	1124	29008	15954	KM4	70	0.1	
15 x 25	0.591	0.984	0.650	0.256	1.260	30	1124	26832	15954	KM4	70	0.1	
16 x 25	0.630	0.984	0.650	0.256	1.260	32	1124	25237	15954	KM4	70	0.1	
17 x 26	0.669	1.024	0.650	0.256	1.260	35	1124	23786	15519	KM4*	70	0.2	
17 x 30	0.669	1.181	0.709	0.256	1.496	41	1349	28572	16244	KM5	118	0.2	
18 x 26	0.709	1.024	0.650	0.256	1.260	36	1124	22481	15519	KM4*	70	0.2	
18 x 30	0.709	1.181	0.709	0.256	1.496	43	1349	26977	16244	KM5	118	0.2	
19 x 30	0.748	1.181	0.709	0.256	1.496	46	1574	25527	16244	KM5	118	0.2	
20 x 30	0.787	1.181	0.709	0.256	1.496	49	1574	24221	16099	KM5	118	0.2	
22 x 32	0.866	1.260	0.709	0.256	1.496	54	1574	22046	15229	KM5*	118	0.2	
22 x 35	0.866	1.378	0.709	0.256	1.772	71	1798	29298	18420	KM6	162	0.2	
24 x 35	0.945	1.378	0.709	0.256	1.772	77	2023	26832	18420	KM6	162	0.2	
25 x 35	0.984	1.378	0.709	0.256	1.772	81	2023	25817	18420	KM6	162	0.2	
28 x 36	1.102	1.417	0.709	0.256	1.772	89	2023	23061	17985	KM6*	162	0.2	
28 x 40	1.102	1.575	0.768	0.276	2.047	111	2248	25527	17840	KM7	251	0.2	
30 x 40	1.181	1.575	0.768	0.276	2.047	118	2473	23786	17840	KM7	251	0.2	
32 x 42	1.260	1.654	0.768	0.276	2.047	125	2473	22336	16969	KM7*	251	0.4	
32 x 45	1.260	1.772	0.846	0.315	2.283	155	2698	24221	17405	KM8	354	0.4	
35 x 45	1.378	1.772	0.846	0.315	2.283	170	2923	22191	17405	KM8	354	0.4	
36 x 45	1.417	1.772	0.846	0.315	2.283	177	2923	21611	17405	KM8	354	0.3	
38 x 48	1.496	1.890	0.846	0.315	2.283	184	2923	20450	16244	KM8*	354	0.6	
38 x 52	1.496	2.047	0.965	0.394	2.559	214	3147	18275	13489	KM9	502	0.6	
40 x 52	1.575	2.047	0.965	0.394	2.559	229	3372	17405	13489	KM9	502	0.5	
42 x 55	1.654	2.165	1.004	0.394	2.559	236	3372	16534	12618	KM9*	502	0.7	
42 x 57	1.654	2.244	1.004	0.394	2.756	273	3822	19000	13924	KM10	642	0.7	
45 x 57	1.772	2.244	1.004	0.394	2.756	295	4047	17695	13924	KM10	642	0.6	
48 x 62	1.890	2.441	1.004	0.394	2.953	369	4721	19580	15229	KM11	715	0.7	
50 x 62	1.969	2.441	1.004	0.394	2.953	384	4721	18855	15229	KM11	715	0.7	
55 x 68	2.165	2.677	1.083	0.472	3.150	450	4946	14939	12183	KM12	811	0.8	
56 x 68	2.205	2.677	1.083	0.472	3.150	457	4946	14649	11893	KM12	811	0.7	
60 x 73	2.362	2.874	1.122	0.472	3.346	590	6070	16389	13489	KM13	959	0.9	
63 x 79	2.480	3.110	1.201	0.551	3.622	723	6969	15519	12473	KM14	1180	1	
65 x 79	2.559	3.110	1.201	0.551	3.622	745	6969	15084	12473	KM14	1180	1	
70 x 84	2.756	3.307	1.240	0.551	3.858	915	7868	15954	13343	KM15	1475	1	

* Without washer

Locking assembly - Not self-centering

TLK 250

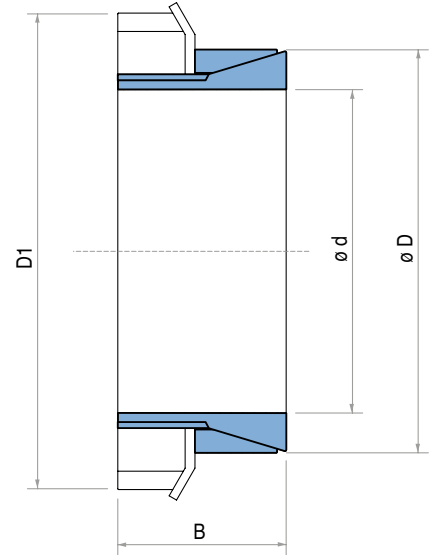

TLK 250L DIMENSIONS

dxD	d	D	B	L1	D1	Torque (max.)	Axial Thrust (max.)	Surface pressures on		Tightening screws			Weight (approx.)
								Shaft	Hub	DIN 912	Tightening Torque	Nut Size	
mm	inch	inch	inch	inch	inch	M _t Lb-ft	F _{ax} Lbf	P _s psi	P _h psi	Nut Size	M _s Lb-ft	Lb	
14 x 25	0.551	0.984	1.181	0.787	1.260	47	2023	12328	6527	KM4	70	0.2	
15 x 25	0.591	0.984	1.181	0.787	1.260	52	2023	11603	6527	KM4	70	0.2	
16 x 25	0.630	0.984	1.181	0.787	1.260	54	2023	10878	6527	KM4	70	0.2	
17 x 25	0.669	0.984	1.260	0.787	1.260	59	2023	10153	6527	KM4 *	70	0.2	
18 x 30	0.709	1.181	1.260	0.787	1.496	74	2248	11603	6527	KM5	118	0.3	
19 x 30	0.748	1.181	1.260	0.787	1.496	77	2473	10878	6527	KM5	118	0.3	
20 x 30	0.787	1.181	1.260	0.787	1.496	83	2473	10153	6527	KM5	118	0.2	
22 x 35	0.866	1.378	1.417	0.984	1.772	120	3147	10153	6527	KM6	162	0.4	
24 x 35	0.945	1.378	1.417	0.984	1.772	131	3147	9427	6527	KM6	162	0.4	
25 x 35	0.984	1.378	1.417	0.984	1.772	136	3147	8702	6527	KM6	162	0.3	
28 x 40	1.102	1.575	1.654	1.181	2.047	184	3822	7977	5802	KM7	251	0.5	
30 x 40	1.181	1.575	1.654	1.181	2.047	199	3822	7252	5802	KM7	251	0.5	
32 x 45	1.260	1.772	1.732	1.181	2.283	258	4721	8702	6527	KM8	354	0.7	
35 x 45	1.378	1.772	1.732	1.181	2.283	288	4721	7977	6527	KM8	354	0.6	
38 x 50	1.496	1.969	1.772	1.181	2.559	369	5845	8702	6527	KM9	502	0.8	
40 x 50	1.575	1.969	1.772	1.181	2.559	384	5845	7977	6527	KM9	502	0.7	
42 x 55	1.654	2.165	1.811	1.181	2.756	465	6744	9427	7252	KM10	642	0.9	
45 x 55	1.772	2.165	1.811	1.181	2.756	502	6744	8702	7252	KM10	642	0.9	
48 x 60	1.890	2.362	1.811	1.181	2.953	620	7868	8702	7252	KM11	715	1	
50 x 60	1.969	2.362	1.811	1.181	2.953	649	7868	8702	7252	KM11	715	1	
55 x 65	2.165	2.559	1.811	1.181	3.150	760	8318	8702	7252	KM12	811	1	
60 x 70	2.362	2.756	2.047	1.181	3.346	1003	10116	9427	7977	KM13	959	1	
70 x 84	2.756	3.307	2.047	1.181	3.858	1549	13489	13634	12328	KM15	1475	2	

* Without washer

Locking assembly self-centering

TLK 250 L

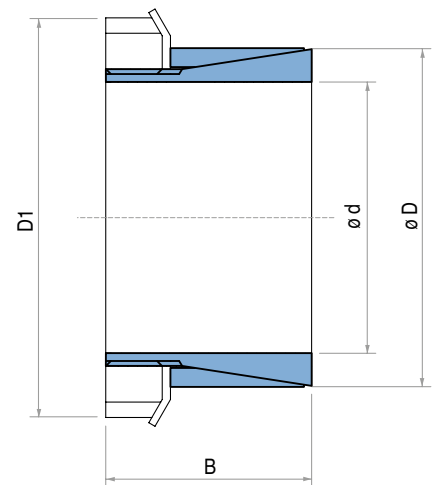

TLK 300

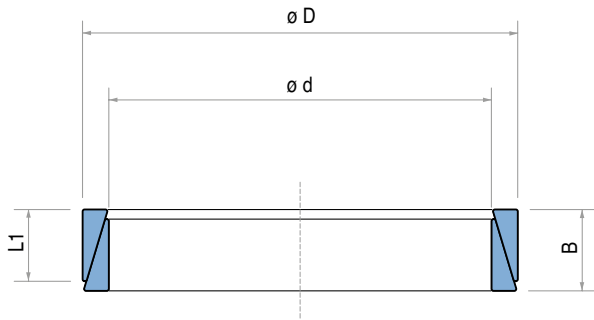
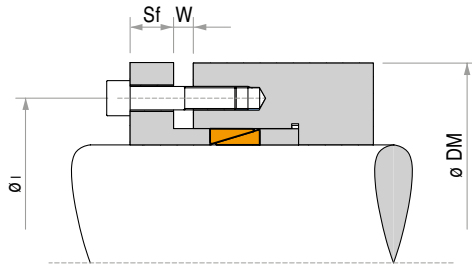

Screws center distance $l = D + 12 + dg$ (screws fixed on the hub) Flange thickness $Sf = dg \cdot 1,3$ (screws quality 8.8)
 Screws center distance $l = d - 12 - dg$ (screws fixed on the shaft) Flange thickness $Sf = dg \cdot 1,8$ (screws quality 12.9)

Note: On request the type TLK 300 can be supplied also with split rings. This will increase the transmissible torque M_t . Please contact our application engineering department for additional information.

Units: Pa & Pt in Lbf M_t in Lb-ft d, D, i & sf in inch dg in mm

Characteristics

- Medium low torque
- Compact space
- Quick installation time
- Application economically advantageous

Installation

Carefully clean the hub and shaft contact surfaces and apply a light oil film. Slide the locking elements into the hub bore, insert the shaft and tighten gradually and regularly in crossed sequence all screws to reach the tightening torque M_s as indicated in the table. The values M_t and F_{ax} indicated in the table are valid only in case of oil installation.

Do not use any oil with **molybdenum bisulphide** or high pressure additives and not grease. Above substances notably reduce the friction coefficient.

Dismantling

By loosening all tightening screws the locking elements are released and the clamping is free. However in case of difficulties slightly hammer the hub.

TLK 300 DIMENSIONS

dg	DIN912			C=0,140		
	Pv in N			Mt in Nm		
	8.8	10.9	12.9	8.8	10.9	12.9
M4	877	1225	1473	2	3	4
M5	1428	2012	2405	4	6	7
M6	2023	2833	3395	7	10	13
[M7]	2967	4159	4991	12	17	21
M8	3709	5216	6272	18	26	30
[M9]	4946	6947	8340	27	38	45
M10	5890	8295	9959	36	51	61
M12	8610	12140	14500	63	89	107
M14	11803	16636	19896	100	140	170
M16	16411	22931	27652	155	218	262
M18	19783	27876	33272	214	299	358
M20	25628	35970	43164	302	428	509
M22	31698	44737	53730	406	575	686
M24	36869	51706	62048	524	738	885
M27	48334	67893	81606	774	1106	1328
M30	58900	82730	99366	1069	1475	1770

$$Pa = N^{\circ} \text{ of screws} \cdot Pv$$

$$Pt = \text{see page 27}$$

$$M_t \text{ transmissible} = \frac{Pa - Pt}{0,54} \cdot 0,12 \cdot \frac{d}{2000}$$

Tolerances, surface finish

A good surface finish by the machine tool is sufficient.

Maximum allowable surface finish:

Rt max 6 μm (Ra 1 μm - Rz 5 μm)

Maximum permissible tolerances:

shaft h6 - hub H7 (up to 40mm d. diameter)

shaft h8 - hub H8 (over 42mm d. diameter)

For exact tolerance values see page 57.

M_t transmissible

Nr. 1 TLK 300 $M_t = M_t \text{ cat.}$

Nr. 2 TLK 300 $M_t = M_t \text{ cat.} \cdot 1,55$

Nr. 3 TLK 300 $M_t = M_t \text{ cat.} \cdot 1,85$

Nr. 4 TLK 300 $M_t = M_t \text{ cat.} \cdot 2,02$

DM hub calculation

The pressure P_h in the hub can be compared to the inside pressure on a thick hollow cylinder.

For DM calculation see page 54.

TLK 300 DIMENSIONS

Dimensions					Pre-load force	Total force	Torque (max.)	Axial thrust (max.)	Distance W before tightening				Spacer diameter inside	Spacer diameter Outside	Surface pressures on Shaft		Weight (approx.)
dxD	d	D	B	L1	P _t	P _a	M _t	F _{ax}	1	2	3	4	d1	D1	P _s	P _h	
mm	inch	inch	inch	inch	Lbf	Lbf	Lb-ft	Lbf	inch	inch	inch	inch	inch	inch	psi	psi	Lb
5 x 8	0.197	0.315	0.177	0.146	-	854	1.5	189	0.098	0.098	0.118	0.157	0.201	0.311	17405	10878	0.1
6 x 9	0.236	0.354	0.177	0.146	-	854	1.5	189	0.098	0.098	0.118	0.157	0.240	0.350	16679	10878	0.1
7 x 10	0.276	0.394	0.177	0.146	-	877	2	193	0.098	0.098	0.118	0.157	0.280	0.390	15229	10153	0.1
8 x 11	0.315	0.433	0.177	0.146	-	1191	4	263	0.098	0.098	0.118	0.157	0.319	0.429	17405	13053	0.1
9 x 12	0.354	0.472	0.177	0.146	1720	3507	6	396	0.098	0.098	0.118	0.157	0.358	0.469	20305	15229	0.1
10 x 13	0.394	0.512	0.177	0.146	1574	3507	7	429	0.098	0.098	0.118	0.157	0.398	0.508	19580	15229	0.1
11 x 14	0.433	0.551	0.177	0.146	1574	3507	8	429	0.098	0.098	0.118	0.157	0.437	0.547	18130	14504	0.1
12 x 15	0.472	0.591	0.177	0.146	1574	3507	8	429	0.098	0.098	0.118	0.157	0.476	0.587	16679	13053	0.1
13 x 16	0.512	0.630	0.177	0.146	1461	3507	10	454	0.098	0.098	0.118	0.157	0.516	0.626	15954	13053	0.1
14 x 18	0.551	0.709	0.248	0.209	2473	5710	16	715	0.138	0.138	0.177	0.217	0.555	0.705	16679	13053	0.1
15 x 19	0.591	0.748	0.248	0.209	2248	5710	18	728	0.138	0.138	0.177	0.217	0.594	0.744	15954	12328	0.1
16 x 20	0.630	0.787	0.248	0.209	2248	5710	20	769	0.138	0.138	0.177	0.217	0.634	0.783	15229	12328	0.1
17 x 21	0.669	0.827	0.248	0.209	2158	5710	22	789	0.138	0.138	0.177	0.217	0.673	0.823	15229	12328	0.1
18 x 22	0.709	0.866	0.248	0.209	2057	5710	24	812	0.138	0.138	0.177	0.217	0.713	0.862	14504	11603	0.1
19 x 24	0.748	0.945	0.248	0.209	2810	8093	36	1174	0.138	0.138	0.177	0.217	0.756	0.937	20305	15954	0.1
20 x 25	0.787	0.984	0.248	0.209	2698	8093	39	1198	0.138	0.138	0.177	0.217	0.795	0.976	19580	15229	0.1
22 x 26	0.866	1.024	0.248	0.209	2023	8093	49	1349	0.138	0.138	0.177	0.217	0.874	1.016	19580	16679	0.1
24 x 28	0.945	1.102	0.248	0.209	1888	8093	54	1378	0.138	0.138	0.177	0.217	0.953	1.094	18855	15954	0.1
25 x 30	0.984	1.181	0.248	0.209	2248	8093	53	1297	0.138	0.138	0.177	0.217	0.992	1.173	16679	13779	0.1
28 x 32	1.102	1.260	0.248	0.209	1686	8093	65	1423	0.138	0.138	0.177	0.217	1.110	1.252	16679	14504	0.1
30 x 35	1.181	1.378	0.248	0.209	1933	8093	67	1367	0.138	0.138	0.177	0.217	1.189	1.370	14504	12328	0.1
32 x 36	1.260	1.417	0.248	0.209	1776	10116	97	1852	0.138	0.138	0.177	0.217	1.268	1.409	18855	16679	0.1
35 x 40	1.378	1.575	0.276	0.236	2248	12140	126	2196	0.138	0.138	0.177	0.217	1.386	1.567	18130	15954	0.1
36 x 42	1.417	1.654	0.276	0.236	2630	12140	125	2111	0.138	0.138	0.177	0.217	1.425	1.646	16679	14504	0.1
38 x 44	1.496	1.732	0.276	0.236	2473	12140	133	2147	0.138	0.138	0.177	0.217	1.504	1.724	15954	13779	0.1
40 x 45	1.575	1.772	0.315	0.260	3125	14837	170	2601	0.138	0.177	0.217	0.256	1.583	1.764	16679	15229	0.1
42 x 48	1.654	1.890	0.315	0.260	3496	14837	173	2522	0.138	0.177	0.217	0.256	1.661	1.882	15954	13779	0.1
45 x 52	1.772	2.047	0.394	0.339	6362	22256	260	3532	0.138	0.177	0.217	0.256	1.780	2.039	15229	13779	0.1
48 x 55	1.890	2.165	0.394	0.339	5553	29675	422	5359	0.138	0.177	0.217	0.256	1.898	2.157	22481	19580	0.1
50 x 57	1.969	2.244	0.394	0.339	5306	29675	444	5413	0.138	0.177	0.217	0.256	1.976	2.236	21756	18855	0.1
55 x 62	2.165	2.441	0.394	0.339	4878	29675	494	5474	0.138	0.177	0.217	0.256	2.173	2.433	20305	18130	0.2
56 x 64	2.205	2.520	0.472	0.409	6632	35340	583	6340	0.138	0.177	0.217	0.276	2.213	2.512	18855	16679	0.2
60 x 68	2.362	2.677	0.472	0.409	6182	35340	634	6430	0.138	0.177	0.217	0.276	2.370	2.669	18130	15954	0.2
63 x 71	2.480	2.795	0.472	0.409	5957	35340	671	6475	0.138	0.177	0.217	0.276	2.488	2.787	17405	15229	0.2
65 x 73	2.559	2.874	0.472	0.409	5733	35340	701	6564	0.138	0.177	0.217	0.276	2.567	2.866	16679	14504	0.2
70 x 79	2.756	3.110	0.551	0.480	6969	47120	1018	8858	0.138	0.197	0.256	0.295	2.768	3.098	18130	15954	0.3
71 x 80	2.795	3.150	0.551	0.480	6969	47120	1033	8858	0.138	0.197	0.256	0.295	2.807	3.138	17405	15954	0.3
75 x 84	2.953	3.307	0.551	0.480	7801	47120	1069	8678	0.138	0.197	0.256	0.295	2.965	3.295	16679	14504	0.3
80 x 91	3.150	3.583	0.669	0.591	10791	65195	1623	12365	0.157	0.236	0.256	0.315	3.161	3.571	18130	15229	0.5
85 x 96	3.346	3.780	0.669	0.591	10229	68567	1770	12679	0.157	0.236	0.256	0.315	3.358	3.768	17405	15229	0.5
90 x 101	3.543	3.976	0.669	0.591	9802	71939	2014	13601	0.157	0.236	0.256	0.315	3.555	3.965	17405	15229	0.5
95 x 106	3.740	4.173	0.669	0.591	9285	74187	2250	14433	0.157	0.236	0.256	0.315	3.752	4.161	17405	15954	0.6
100 x 114	3.937	4.488	0.827	0.736	13713	100040	3098	18884	0.197	0.236	0.276	0.354	3.949	4.476	17405	15229	0.9
110 x 124	4.331	4.882	0.827	0.736	14837	109033	3798	21042	0.197	0.236	0.276	0.354	4.343	4.870	17405	15229	1
120 x 134	4.724	5.276	0.827	0.736	13556	114653	4462	22661	0.197	0.236	0.276	0.354	4.732	5.264	17405	15229	1
130 x 148	5.118	5.827	1.102	0.996	21649	171980	7081	33182	0.197	0.276	0.354	0.433	5.134	5.811	17405	15229	2
140 x 158	5.512	6.220	1.102	0.996	20008	179960	8113	35632	0.236	0.276	0.354	0.433	5.528	6.205	17405	15229	2
150 x 168	5.906	6.614	1.102	0.996	19109	193337	9515	38667	0.236	0.276	0.315	0.433	5.921	6.598	17405	15229	2
160 x 178	6.299	7.008	1.102	0.996	17670	202329	10768	41028	0.236	0.276	0.354	0.433	6.315	6.992	17405	15954	2
170 x 191	6.693	7.520	1.299	1.181	26393	260780	14382	51481	0.276	0.354	0.394	0.472	6.713	7.500	17405	15229	3
180 x 201	7.087	7.913	1.299	1.181	25021	269772	15710	53055	0.276	0.354	0.394	0.472	7.106	7.894	17405	15229	3
190 x 211	7.480	8.307	1.299	1.181	23605	283261	17849	57327	0.276	0.354	0.394	0.472	7.500	8.287	17405	15954	4
200 x 224	7.874	8.819	1.496	1.370	30170	348456	22864	69691	0.276	0.315	0.433	0.512	7.898	8.795	17405	15229	5
210 x 234	8.268	9.213	1.496	1.370	28596	361944	25815	74862	0.276	0.354	0.433	0.512	8.291	9.189	17405	15954	6
220 x 244	8.661	9.606	1.496	1.370	27449	379929	28027	77559	0.276	0.354	0.433	0.512	8.685	9.583	17405	15954	6
230 x 257	9.055	10.118	1.693	1.555	36981	449620	34665	91722	0.276	0.394	0.472	0.551	9.079	10.094	17405	15229	7
240 x 267	9.449	10.512	1.693	1.555	35385	505823	37616	95544	0.276	0.394	0.472	0.551	9.472	10.488	17405	15954	8
250 x 280	9.843	11.024	1.890	1.732	42714	463109	38353	93296	0.276	0.394	0.512	0.630	9.874	10.992	14504	12908	11
260 x 290	10.236	11.417	1.890	1.732	40915	479295	41672	97792	0.276	0.394	0.512	0.630	10.268	11.386	14504	12908	11
270 x 300	10.630	11.811	1.890	1.732	39791	496156	44991	101165	0.276	0.394	0.512	0.630	10.661	11.780	14504	12908	11
280 x 313	11.024	12.323	2.087	1.929	46311	570118	53473	116901	0.276	0.433	0.551	0.669	11.055	12.291	14504	12908	14
290 x 323	11.417	12.717	2.087	1.929	49908	591700	57161	120273	0.276	0.433	0.551	0.669	11.449	12.685	14504	12908	14
300 x 333	11.811	13.110	2.087	1.929	48109	607886	61217	124770	0.276	0.433	0.551	0.669	11.842	13.079	14504	12908	15
320 x 360	12.598	14.173	2.559	2.323	65645	785037	84082	159615	0.394	0.591	0.787	0.984	12.638	14.134	14504	12908	24
340 x 380	13.386	14.961	2.559	2.323	61148	825502	94776	169732	0.394	0.591	0.787	0.984	13.425	14.921	14504	12908	25
360 x 400	14.173	15.748	2.559	2.323	58001	867317	106209	179848	0.394</								

TLK 350

TLK 350 DIMENSIONS

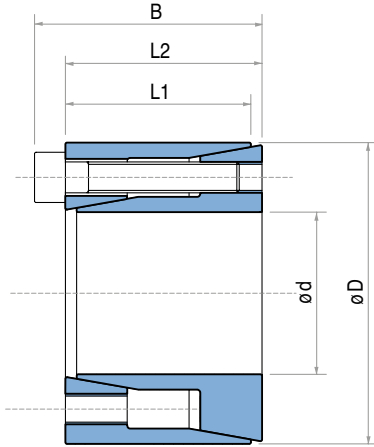

dD	d	D	L1	L2	B	M _t	F _{ax}	Surface pressures on		Tightening screws		Weight (approx.)
								Shaft	Hub	DIN 912	Tightening Torque	
mm	inch	inch	inch	inch	inch	Lb-ft	Lbf	psi	psi	n x type	Lb-ft	Lb
1/4	0.2500	0.630	0.413	0.433	0.531	7	685	25157	9984	3 x M2.5	1	0.1
5/16	0.3125	0.709	0.413	0.433	0.531	9	685	20126	8875	3 x M2.5	1	0.1
3/8	0.3750	0.787	0.492	0.512	0.610	14	913	18922	9011	4 x M2.5	1	0.1
7/16	0.4375	0.866	0.492	0.512	0.610	17	913	16218	8192	4 x M2.5	1	0.1
1/2	0.5000	1.024	0.650	0.669	0.787	28	1333	15854	7744	4 x M3	2	0.1
5/8	0.6250	1.260	0.650	0.669	0.827	61	2335	22213	11020	4 x M4	4	0.2
3/4	0.7500	1.378	0.807	0.827	0.984	73	2335	14985	8156	4 x M4	4	0.2
7/8	0.8750	1.575	0.807	0.827	1.024	138	3815	20982	11658	4 x M5	7	0.3
15/16	0.9375	1.850	0.984	1.024	1.260	208	5383	22321	11309	4 x M6	13	0.5
1	1.0000	1.850	0.984	1.024	1.260	222	5383	20926	11309	4 x M6	13	0.5
1 1/8	1.1250	1.969	0.984	1.024	1.260	376	8075	27902	15946	6 x M6	13	0.5
1 3/16	1.1875	2.165	0.984	1.024	1.260	396	8075	26433	14496	6 x M6	13	1
1 1/4	1.2500	2.165	0.984	1.024	1.260	417	8075	25112	14496	6 x M6	13	1
1 3/8	1.3750	2.362	1.181	1.220	1.457	611	10767	25529	14860	8 x M6	13	1
1 7/16	1.4375	2.559	1.181	1.220	1.457	639	10767	24419	13717	8 x M6	13	1
1 1/2	1.5000	2.559	1.181	1.220	1.457	667	10767	23402	13717	8 x M6	13	1
1 5/8	1.6250	2.953	1.378	1.417	1.732	1000	14920	25777	14186	6 x M8	30	2
1 11/16	1.6875	2.953	1.378	1.417	1.732	1039	14920	24822	14186	6 x M8	30	2
1 3/4	1.7500	2.953	1.378	1.417	1.732	1078	14920	23936	14186	6 x M8	30	2
1 7/8	1.8750	3.150	1.378	1.417	1.732	1539	19894	29787	17732	8 x M8	30	2
1 15/16	1.9375	3.150	1.378	1.417	1.732	1590	19894	28826	17732	8 x M8	30	2

dxD	d	D	B	L1	D1	M _t	F _{ax}	Surface pressures on		Tightening screws		Weight (approx.)
								Shaft	Hub	DIN 912	Tightening Torque	
mm	inch	inch	inch	inch	inch	Lb-ft	Lbf	psi	psi	Nut Size	Lb-ft	Lb
6 x 16	0.236	0.630	0.413	0.433	0.531	7	674	26687	10008	3 x M2.5	1	0.1
7 x 17	0.276	0.669	0.413	0.433	0.531	8	674	22771	9427	3 x M2.5	1	0.1
8 x 18	0.315	0.709	0.413	0.433	0.531	9	674	20015	8847	3 x M2.5	1	0.1
9 x 20	0.354	0.787	0.492	0.512	0.610	13	899	20015	8992	4 x M2.5	1	0.1
10 x 20	0.394	0.787	0.492	0.512	0.610	15	899	17985	8992	4 x M2.5	1	0.1
11 x 22	0.433	0.866	0.492	0.512	0.610	16	899	16389	8122	4 x M2.5	1	0.1
12 x 22	0.472	0.866	0.492	0.512	0.610	18	899	15084	8122	4 x M2.5	1	0.1
14 x 26	0.551	1.024	0.650	0.669	0.787	31	1349	14359	7687	4 x M3	2	0.1
15 x 28	0.591	1.102	0.650	0.669	0.787	32	1349	13489	7252	4 x M3	2	0.1
16 x 32	0.630	1.260	0.650	0.669	0.827	61	2338	22046	11023	4 x M4	4	0.2
17 x 35	0.669	1.378	0.807	0.827	0.984	65	2338	16824	8122	4 x M4	4	0.2
18 x 35	0.709	1.378	0.807	0.827	0.984	69	2338	15809	8122	4 x M4	4	0.2
19 x 35	0.748	1.378	0.807	0.827	0.984	73	2338	15084	8122	4 x M4	4	0.2
20 x 38	0.787	1.496	0.807	0.827	1.024	125	3822	23351	12328	4 x M5	7	0.3
22 x 40	0.866	1.575	0.807	0.827	1.024	138	3822	21176	11603	4 x M5	7	0.3
24 x 47	0.945	1.850	0.984	1.024	1.260	212	5395	22191	11313	4 x M6	13	0.5
25 x 47	0.984	1.850	0.984	1.024	1.260	221	5395	21321	11313	4 x M6	13	0.5
28 x 50	1.102	1.969	0.984	1.024	1.260	371	8093	28427	15954	6 x M6	13	0.5
30 x 55	1.181	2.165	0.984	1.024	1.260	398	8093	26542	14504	6 x M6	13	1
32 x 55	1.260	2.165	0.984	1.024	1.260	424	8093	24946	14504	6 x M6	13	1
35 x 60	1.378	2.362	1.181	1.220	1.457	618	10791	25527	14794	8 x M6	13	1
38 x 65	1.496	2.559	1.181	1.220	1.457	671	10791	23496	13779	8 x M6	13	1
40 x 65	1.575	2.559	1.181	1.220	1.457	707	10791	22336	13779	8 x M6	13	1
42 x 75	1.654	2.953	1.378	1.417	1.732	1028	14905	25382	14214	6 x M8	30	2
45 x 75	1.772	2.953	1.378	1.417	1.732	1101	14905	23641	14214	6 x M8	30	2
48 x 80	1.890	3.150	1.378	1.417	1.732	1567	19896	29588	17695	8 x M8	30	2
50 x 80	1.969	3.150	1.378	1.417	1.732	1631	19896	28427	17695	8 x M8	30	2

Characteristics

- Medium-high torque
- Easy mounting
- Quick installation time
- Few clamping screws
- Small dimensions
- For other information, see TLK 132.

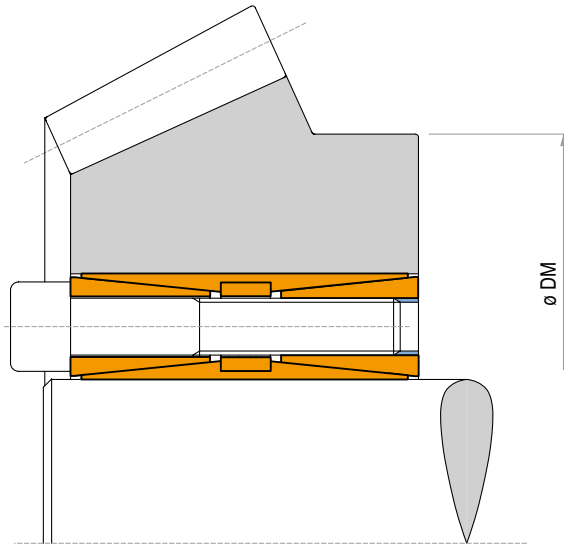

Characteristics

- Very high torques
- Capacity to withstand bending moments
- Even pressures distribution
- No shaft-hub axial movement
- Excellent for Drum pulleys, motorized pulleys

Installation

Carefully clean the hub and shaft contact surfaces and apply a light oil film. Slide the locking assembly into the hub bore and insert the shaft. Tighten gradually and regularly in crossed sequence all screws up to 50% of the M_s value indicated in the table. Repeat the same operation by tightening all screws at the M_s torque indicated in the table.

Starting from the last tightened screw, check, in continuous sequence, that all the screws are tightened at the tightening torque M_s indicated. Repeat this procedure maximum twice. After this control any further operation is needed.

Do not use any oil with molybdenum bisulphide or high pressure additives and not grease. Above substances notably reduce the friction coefficient. For additional information on installation refer to page 58.

Dismantling

Loosen the clamping screws. Insert the screws into the dismantling threads of the front cone and tighten them gradually in crossed sequence up to 50% of the M_s value indicated in the table. Repeat the same operation by tightening the screws at the tightening torque M_s indicated in the table. When the front cone is loose, to release the rear cone, insert the screws in the middle ring, and repeat the same operation of the upper ring. For additional information on dismantling refer to page 58.

Tolerances, surface finish

A good surface finish by the machine tool is sufficient.
Maximum allowable surface finish:
Rt max 16 μm (Ra 3 μm - Rz 13 μm)

Maximum permissible tolerances:

h8 for shaft
H8 for hub

For exact tolerance values see page 57.

Axial movement

During tightening of mounting screws the hub has no axial movement with respect to the shaft.

DM hub calculation

For DM calculation see page 54.

ATTENTION: In case of reuse of the TLK 400 or TLK 401 check that the position of the dismantling threads of the front cone and middle ring are like in new pieces.

TLK 400

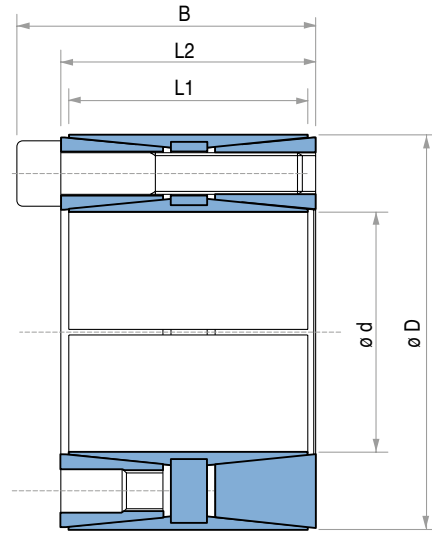

TLK 400 DIMENSIONS

dxD mm	d inch	D inch	L1 inch	L2 inch	B inch	Torque (max.) M _t Lb-ft	Axial Thrust (max.) F _{ax} Lbf	Surface pressures on		Tightening screws		Weight (approx.) Lb
								Shaft P _s psi	Hub P _h psi	DIN 912 n x type	Tightening Torque M _s Lb-ft	
45 x 75	1.772	2.953	2.205	2.520	2.835	2552	34846	23931	14504	8 x M8	30	3
48 x 80	1.890	3.150	2.205	2.520	2.835	2714	34846	21756	13779	8 x M8	30	3
50 x 80	1.969	3.150	2.205	2.520	2.835	2817	34846	21321	13779	8 x M8	30	3
55 x 85	2.165	3.346	2.205	2.520	2.835	3142	34846	19580	12328	8 x M8	30	3
60 x 90	2.362	3.543	2.205	2.520	2.835	4293	42714	22481	14504	10 x M8	30	3
65 x 95	2.559	3.740	2.205	2.520	2.835	4625	42714	20305	13779	10 x M8	30	4
70 x 110	2.756	4.331	2.756	3.071	3.465	7914	68567	24656	15229	10 x M10	61	7
75 x 115	2.953	4.528	2.756	3.071	3.465	8511	68567	22481	14504	10 x M10	61	7
80 x 120	3.150	4.724	2.756	3.071	3.465	10842	82955	25382	16679	12 x M10	61	8
85 x 125	3.346	4.921	2.756	3.071	3.465	11580	82955	23931	15954	12 x M10	61	8
90 x 130	3.543	5.118	2.756	3.071	3.465	12251	83180	22771	15374	12 x M10	61	8
95 x 135	3.740	5.315	2.756	3.071	3.465	12929	83180	21756	14794	12 x M10	61	9
100 x 145	3.937	5.709	3.543	3.937	4.409	19840	120948	23206	15954	12 x M12	107	13
110 x 155	4.331	6.102	3.543	3.937	4.409	21780	120948	20740	14794	12 x M12	107	14
120 x 165	4.724	6.496	3.543	3.937	4.409	27740	141181	22336	16244	14 x M12	107	15
130 x 180	5.118	7.087	4.094	4.567	5.118	35403	165910	20740	15374	12 x M14	170	22
140 x 190	5.512	7.480	4.094	4.567	5.118	44467	193561	23206	16969	14 x M14	170	22
150 x 200	5.906	7.874	4.094	4.567	5.118	54432	221438	23931	18130	16 x M14	170	24
160 x 210	6.299	8.268	4.094	4.567	5.118	58098	220988	22481	17114	16 x M14	170	25
170 x 225	6.693	8.858	5.276	5.748	6.378	75032	269098	20305	15664	14 x M16	262	38
180 x 235	7.087	9.252	5.276	5.748	6.378	90867	307765	21756	16679	16 x M16	262	40
190 x 250	7.480	9.843	5.276	5.748	6.378	95794	307540	20450	15954	16 x M16	262	47
200 x 260	7.874	10.236	5.276	5.748	6.378	100928	307540	19870	15084	16 x M16	262	49
220 x 285	8.661	11.220	5.276	5.748	6.378	138661	384425	22481	17405	20 x M16	262	55
240 x 305	9.449	12.008	5.276	5.748	6.378	165951	422643	22481	17405	22 x M16	262	60
260 x 325	10.236	12.795	5.276	5.748	6.378	179965	422643	22481	16679	22 x M16	262	66
280 x 355	11.024	13.976	6.496	6.968	7.756	275110	600243	21030	17405	20 x M20	509	101
300 x 375	11.811	14.764	6.496	6.968	7.756	324526	658693	22481	18130	22 x M20	509	110
320 x 405	12.598	15.945	6.496	6.968	7.756	346653	658693	21030	16679	22 x M20	509	132
340 x 425	13.386	16.732	6.496	6.968	7.756	401233	719392	21756	17405	24 x M20	509	143
360 x 455	14.173	17.913	7.480	7.953	8.819	485314	820557	20305	15954	22 x M22	686	196
380 x 475	14.961	18.701	7.480	7.953	8.819	605537	971179	23206	18855	26 x M22	686	205
400 x 495	15.748	19.488	7.480	7.953	8.819	637252	971179	21756	17405	26 x M22	686	216

For larger diameter please contact our application engineering department. NOTE: it is possible to reduce the screws tightening torque down to 60% of the values indicated in the above table; as a result the M_t, F_{ax}, P_s, P_h are reduced proportionally.

TLK 401 TLK 401.0

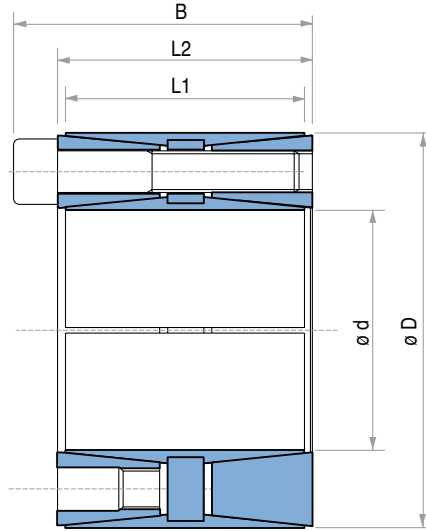

TLK 401 DIMENSIONS

dxD mm	d inch	D inch	L1 inch	L2 inch	B inch	M _t Lb-ft	Axial Thrust F _{ax} Lbf	Surface pressures on		Tightening screws		Weight (approx.) Lb
								Shaft P _s psi	Hub P _h psi	DIN 912 n x type	Tightening Torque M _s Lb-ft	
70 x 110	2.756	4.331	1.969	2.283	2.677	3762	32597	16244	10298	8 x M10	36	5
75 x 115	2.953	4.528	1.969	2.283	2.677	3998	32597	14939	9863	8 x M10	36	5
80 x 120	3.150	4.724	1.969	2.283	2.677	4293	32597	14069	9427	8 x M10	36	6
85 x 125	3.346	4.921	1.969	2.283	2.677	5679	40915	16534	11168	10 x M10	36	6
90 x 130	3.543	5.118	1.969	2.283	2.677	5974	40915	15519	10733	10 x M10	36	6
95 x 135	3.740	5.315	1.969	2.283	2.677	6343	40915	14794	10443	10 x M10	36	6
100 x 145	3.937	5.709	2.362	2.756	3.150	6712	40915	11603	7977	10 x M10	36	9
110 x 155	4.331	6.102	2.362	2.756	3.150	7376	40915	10878	7542	10 x M10	36	10
120 x 165	4.724	6.496	2.362	2.756	3.150	9662	49009	11603	8557	12 x M10	36	11
130 x 180	5.118	7.087	2.677	3.150	3.622	15267	71714	13779	10008	12 x M12	63	14
140 x 190	5.512	7.480	2.677	3.150	3.622	16448	71714	12908	9572	12 x M12	63	15
150 x 200	5.906	7.874	2.677	3.150	3.622	17628	71714	12038	8992	12 x M12	63	15
160 x 210	6.299	8.268	2.677	3.150	3.622	21979	83629	13053	10008	14 x M12	63	16
170 x 225	6.693	8.858	2.953	3.425	3.898	26700	95769	12908	9718	16 x M12	63	22
180 x 235	7.087	9.252	2.953	3.425	3.898	28249	95769	12183	9282	16 x M12	63	25
190 x 250	7.480	9.843	3.465	3.937	4.409	33559	107684	11023	8412	18 x M12	63	31
200 x 260	7.874	10.236	3.465	3.937	4.409	35329	107684	10443	8122	18 x M12	63	34
220 x 285	8.661	11.220	3.858	4.331	4.882	41451	114878	9137	7107	14 x M14	100	43
240 x 305	9.449	12.008	3.858	4.331	4.882	58120	147700	10733	8412	18 x M14	100	47
260 x 325	10.236	12.795	3.858	4.331	4.882	69994	164111	11023	8847	20 x M14	100	51
280 x 355	11.024	13.976	4.724	5.197	5.827	104734	228182	11603	9137	20 x M16	155	64
300 x 375	11.811	14.764	4.724	5.197	5.827	134236	273819	12908	10443	24 x M16	155	67
320 x 405	12.598	15.945	5.315	5.787	6.417	143087	273819	10878	8702	24 x M16	155	104
340 x 425	13.386	16.732	5.315	5.787	6.417	152675	273819	10298	8267	24 x M16	155	110

For larger diameter please contact our application engineering department.

TLK 450

TLK 451 TLK 452

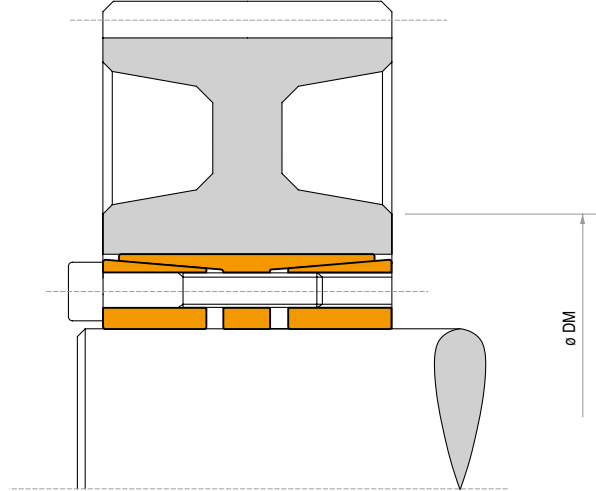
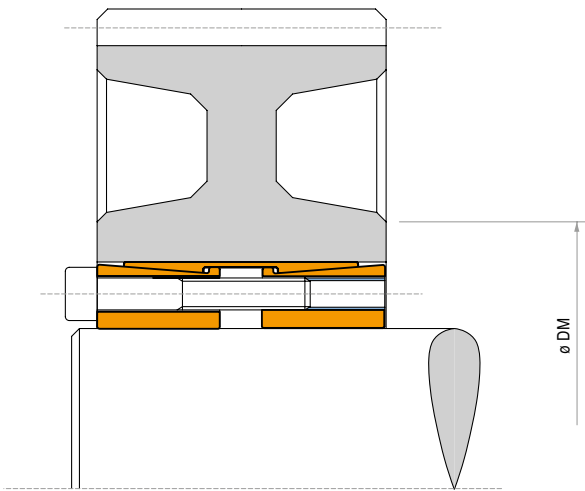

Characteristics

- Very high torques
- Capacity to withstand bending moments
- Compact size
- Excellent for bulk handling applications, drum pulleys

Installation

Carefully clean the hub and shaft contact surfaces and apply a light oil film. Slide the locking assembly into the hub bore and insert the shaft. Tighten gradually and regularly in crossed sequence all screws up to 50% of the M_s value indicated in the table. Repeat the same operation by tightening all screws at the M_s torque indicated in the table.

Starting from the last tightened screw, check, in continuous sequence, that all the screws are tightened at the tightening torque M_s indicated. Repeat this procedure maximum twice.

Do not use any oil with **molybdenum bisulphide** or high pressure additives and not grease. Above substances notably reduce the friction coefficient.

Dismantling

Loosen the clamping screws. Insert the screws into the dismantling threads of the front cone and tighten them gradually in crossed sequence up to 50% of the M_s value indicated in the table. Repeat the same operation by tightening the screws at the tightening torque M_s indicated in the table.

When the front cone is loose, to release the rear cone:

TLK 450: keep tightening the screws and repeat the sequence above.

TLK 451/452: insert the screws in the middle flange and repeat the same operation of the upper ring.

For additional information on dismantling refer to page 58.

Tolerances, surface finish

A good surface finish by the machine tool is sufficient.

Maximum allowable surface finish:

Rt max 16 μm (Ra 3 μm - Rz 13 μm)

Maximum permissible tolerances:

h8 for shaft

H8 for hub

For exact tolerance values see page 57.

DM hub calculation

For DM calculation see page 54.

ATTENTION: In case of reusing TLK451 check that the position of all dismantling threads of the front cone are positioned correctly. The dismantling threads have to be blind due to the middle flange construction.

Locking assembly - Self-centering

TLK 450

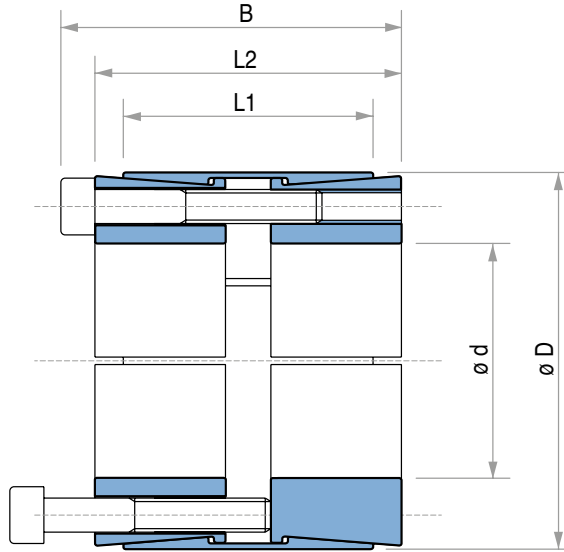

TLK 450 DIMENSIONS

Dimensions						Torque (max.) M _t Lb-ft	Axial Thrust (max.) F _{ax} Lbf	Surface pressures on		Tightening screws		Weight (approx.) Lb
dxD mm	d inch	D inch	L1 inch	L2 inch	B inch			P _s psi	P _h psi	DIN 912 n x type	Tightening torque M _s Lb-ft	
25 x 50	0.984	1.969	1.535	1.772	2.008	701	17086	35534	17695	8 x M6	13	1
28 x 55	1.102	2.165	1.535	1.772	2.008	789	17086	31763	16099	8 x M6	13	1
30 x 55	1.181	2.165	1.535	1.772	2.008	848	17086	29588	16099	8 x M6	13	1
35 x 60	1.378	2.362	1.535	1.772	2.008	988	17086	25382	14794	8 x M6	13	2
38 x 65	1.496	2.559	1.535	1.772	2.008	1069	17086	23351	13634	8 x M6	13	2
40 x 65	1.575	2.559	1.535	1.772	2.008	1128	17086	22191	13634	8 x M6	13	2
42 x 75	1.654	2.953	2.205	2.520	2.835	2191	31698	27267	15229	8 x M8	30	2
45 x 75	1.772	2.953	2.205	2.520	2.835	2323	31698	25382	15229	8 x M8	30	2
48 x 80	1.890	3.150	2.205	2.520	2.835	2950	37318	23786	14214	8 x M8	30	3
50 x 80	1.969	3.150	2.205	2.520	2.835	3061	37318	22916	14214	8 x M8	30	3
55 x 85	2.165	3.346	2.205	2.520	2.835	3356	37318	20740	13489	8 x M8	30	3
60 x 90	2.362	3.543	2.205	2.520	2.835	4573	46536	23786	15809	10 x M8	30	4
65 x 95	2.559	3.740	2.205	2.520	2.835	4979	46536	22046	15084	10 x M8	30	4
70 x 110	2.756	4.331	2.756	3.071	3.465	8519	74187	25962	16534	10 x M10	61	7
75 x 115	2.953	4.528	2.756	3.071	3.465	9109	74187	24221	15809	10 x M10	61	7
80 x 120	3.150	4.724	2.756	3.071	3.465	11653	89025	27267	18130	12 x M10	61	8
85 x 125	3.346	4.921	2.756	3.071	3.465	12391	89025	25672	17405	12 x M10	61	8
90 x 130	3.543	5.118	2.756	3.071	3.465	13129	89025	24221	16679	12 x M10	61	8
95 x 135	3.740	5.315	2.756	3.071	3.465	13866	89025	22916	16099	12 x M10	61	11
100 x 145	3.937	5.709	3.543	3.937	4.409	21242	129491	24656	16969	12 x M12	107	13
110 x 155	4.331	6.102	3.543	3.937	4.409	23381	129491	22481	15954	12 x M12	107	14
120 x 165	4.724	6.496	3.543	3.937	4.409	29724	151297	23931	17405	14 x M12	107	16
130 x 180	5.118	7.087	4.094	4.567	5.118	37911	177825	22481	16244	12 x M14	170	22
140 x 190	5.512	7.480	4.094	4.567	5.118	47646	207500	24366	17985	14 x M14	170	22
150 x 200	5.906	7.874	4.094	4.567	5.118	58341	237175	25962	19580	16 x M14	170	24
160 x 210	6.299	8.268	4.094	4.567	5.118	62250	237175	24366	18565	16 x M14	170	25
170 x 225	6.693	8.858	5.276	5.748	6.378	80394	288431	21611	16389	14 x M16	262	37
180 x 235	7.087	9.252	5.276	5.748	6.378	97358	329571	23351	17985	16 x M16	262	41
190 x 250	7.480	9.843	5.276	5.748	6.378	102521	329571	22191	16824	16 x M16	262	47
200 x 260	7.874	10.236	5.276	5.748	6.378	108053	329571	21030	16244	16 x M16	262	49
220 x 285	8.661	11.220	5.276	5.748	6.378	148618	412077	23931	18420	20 x M16	262	55
240 x 305	9.449	12.008	5.276	5.748	6.378	178490	453442	24076	19000	22 x M16	262	60
260 x 325	10.236	12.795	5.276	5.748	6.378	193241	453442	22336	17840	22 x M16	262	66
280 x 355	11.024	13.976	6.496	6.968	7.756	295024	643406	23786	18855	20 x M20	509	101
300 x 375	11.811	14.764	6.496	6.968	7.756	348128	707702	24511	19580	22 x M20	509	110
320 x 405	12.598	15.945	6.496	6.968	7.756	371361	707702	22916	18130	22 x M20	509	132
340 x 425	13.386	16.732	6.496	6.968	7.756	430366	771998	23496	18855	24 x M20	509	143
360 x 455	14.173	17.913	7.480	7.953	8.819	519980	880806	22046	17405	22 x M22	686	196
380 x 475	14.961	18.701	7.480	7.953	8.819	649053	1041095	24656	19725	26 x M22	686	205
400 x 495	15.748	19.488	7.480	7.953	8.819	682981	1041095	23496	19000	26 x M22	686	216

For larger diameter or inch series please contact us.

NOTE: it is possible to reduce the screws tightening torque down to 60% of the values indicated in above table; as a result M_t, F_{ax}, P_w, P_n are reduced proportionally.

TLK 450 DIMENSIONS

Dimensions						Torque (max.)	Axial Thrust (max.)	Surface pressures on		Tightening screws		Weight (approx.)
								Shaft	Hub	DIN 912	Tightening torque	
d inch	d inch	D inch	L1 inch	L2 inch	B inch	M _t Lb-ft	F _{ax} Lbf	P _s psi	P _h psi	12.9 n x type	M _s Lb-ft	Lb
1	1.0000	2.165	1.535	1.772	2.008	826	20239	34965	16147	8 x M6	13	1
1 3/16	1.1875	2.165	1.535	1.772	2.008	981	20239	29444	16147	8 x M6	13	1
1 1/4	1.2500	2.362	1.535	1.772	2.008	1033	20239	27972	14802	8 x M6	13	2
1 3/8	1.3750	2.362	1.535	1.772	2.008	1137	20239	25429	14802	8 x M6	13	2
1 7/16	1.4375	2.362	1.535	1.772	2.008	1188	20239	24323	14802	8 x M6	13	2
1 1/2	1.5000	2.953	2.205	2.520	2.835	2290	37394	29994	15237	8 x M8	30	2
1 5/8	1.6250	2.953	2.205	2.520	2.835	2481	37394	27687	15237	8 x M8	30	2
1 3/4	1.7500	2.953	2.205	2.520	2.835	2672	37394	25709	15237	8 x M8	30	2
1 7/8	1.8750	3.150	2.205	2.520	2.835	2863	37394	23996	14285	8 x M8	30	3
1 15/16	1.9375	3.150	2.205	2.520	2.835	2959	37394	23221	14285	8 x M8	30	3
2	2.0000	3.150	2.205	2.520	2.835	3054	37394	22496	14285	8 x M8	30	3
2 1/8	2.1250	3.346	2.205	2.520	2.835	3245	37394	21173	13445	8 x M8	30	3
2 3/16	2.1875	3.346	2.205	2.520	2.835	3340	37394	20568	13445	8 x M8	30	3
2 1/4	2.2500	3.543	2.205	2.520	2.835	4294	46743	24995	15872	10 x M8	30	4
2 3/8	2.3750	3.543	2.205	2.520	2.835	4533	46743	23680	15872	10 x M8	30	4
2 7/16	2.4375	3.740	2.205	2.520	2.835	4652	46743	23073	15037	10 x M8	30	4
2 1/2	2.5000	3.740	2.205	2.520	2.835	4772	46743	22496	15037	10 x M8	30	4
2 9/16	2.5625	3.740	2.205	2.520	2.835	4891	46743	21947	15037	10 x M8	30	4
2 5/8	2.6250	4.331	2.756	3.071	3.465	7956	74219	27215	16496	10 x M10	61	7
2 11/16	2.6875	4.331	2.756	3.071	3.465	8145	74219	26582	16496	10 x M10	61	7
2 3/4	2.7500	4.331	2.756	3.071	3.465	8334	74219	25978	16496	10 x M10	61	7
2 7/8	2.8750	4.331	2.756	3.071	3.465	8713	74219	24848	16496	10 x M10	61	7
2 15/16	2.9375	4.724	2.756	3.071	3.465	10683	89063	29183	18145	12 x M10	61	8
3	3.0000	4.724	2.756	3.071	3.465	10910	89063	28575	18145	12 x M10	61	8
3 1/8	3.1250	4.724	2.756	3.071	3.465	11365	89063	27432	18145	12 x M10	61	8
3 1/4	3.2500	4.724	2.756	3.071	3.465	11820	89063	26377	18145	12 x M10	61	8
3 3/8	3.3750	5.118	2.756	3.071	3.465	12274	89063	25400	16750	12 x M10	61	8
3 7/16	3.4375	5.118	2.756	3.071	3.465	12501	89063	24938	16750	12 x M10	61	8
3 1/2	3.5000	5.118	2.756	3.071	3.465	12728	89063	24493	16750	12 x M10	61	8
3 5/8	3.6250	5.118	2.756	3.071	3.465	13183	89063	23649	16750	12 x M10	61	8
3 3/4	3.7500	5.709	3.543	3.937	4.409	19857	129674	25888	17006	12 x M12	107	13
3 7/8	3.8750	5.709	3.543	3.937	4.409	20518	129674	25053	17006	12 x M12	107	13
3 15/16	3.9375	5.709	3.543	3.937	4.409	20850	129674	24655	17006	12 x M12	107	13
4	4.0000	5.709	3.543	3.937	4.409	21180	129674	24270	17006	12 x M12	107	13
4 1/4	4.2500	6.102	3.543	3.937	4.409	22504	129674	22842	15908	12 x M12	107	14
4 3/8	4.3750	6.102	3.543	3.937	4.409	23165	129674	22189	15908	12 x M12	107	14
4 7/16	4.4375	6.496	3.543	3.937	4.409	27413	151287	25523	17435	14 x M12	107	16
4 1/2	4.5000	6.496	3.543	3.937	4.409	27799	151287	25169	17435	14 x M12	107	16
4 3/4	4.7500	6.496	3.543	3.937	4.409	29343	151287	23844	17435	14 x M12	107	16
4 15/16	4.9375	7.087	4.094	4.567	5.118	35872	177925	23346	16266	12 x M14	170	22
5	5.0000	7.087	4.094	4.567	5.118	36327	177925	23054	16266	12 x M14	170	22
5 1/4	5.2500	7.480	4.094	4.567	5.118	44500	207579	25616	17978	14 x M14	170	22
5 7/16	5.4375	7.480	4.094	4.567	5.118	46089	207579	24732	17978	14 x M14	170	22
5 1/2	5.5000	7.480	4.094	4.567	5.118	46619	207579	24451	17978	14 x M14	170	22
5 3/4	5.7500	7.874	4.094	4.567	5.118	55700	237234	26729	19519	16 x M14	170	24
5 15/16	5.9375	7.874	4.094	4.567	5.118	57517	237234	25885	19519	16 x M14	170	24
6	6.0000	8.268	4.094	4.567	5.118	58123	237234	25616	18590	16 x M14	170	25
6 7/16	6.4375	8.858	5.276	5.748	6.378	75836	288500	22534	16376	14 x M16	262	37
6 1/2	6.5000	8.858	5.276	5.748	6.378	76572	288500	22317	16376	14 x M16	262	37
6 15/16	6.9375	9.252	5.276	5.748	6.378	93402	329715	23897	17919	16 x M16	262	41
7	7.0000	9.252	5.276	5.748	6.378	94244	329715	23684	17919	16 x M16	262	41
7 1/4	7.2500	9.843	5.276	5.748	6.378	97609	329715	22867	16844	16 x M16	262	47
7 7/16	7.4375	9.843	5.276	5.748	6.378	100133	329715	22290	16844	16 x M16	262	47
7 1/2	7.5000	9.843	5.276	5.748	6.378	100975	329715	22105	16844	16 x M16	262	47
7 3/4	7.7500	10.236	5.276	5.748	6.378	104341	329715	21392	16196	16 x M16	262	49
7 15/16	7.9375	10.236	5.276	5.748	6.378	106865	329715	20886	16196	16 x M16	262	49
8	8.0000	10.236	5.276	5.748	6.378	107707	329715	20723	16196	16 x M16	262	49

For larger diameter or inch series please contact us.
 NOTE: it is possible to reduce the screws tightening torque down to 60% of the values indicated in above table;
 as a result M_t, F_{ax}, P_{ss}, P_h are reduced proportionally.

TLK 451

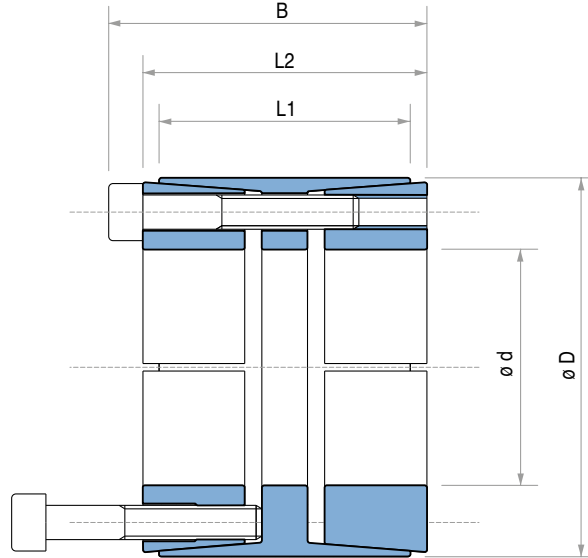

TLK 451 DIMENSIONS

Dimensions						Torque (max.) M_t Lb-ft	Axial Thrust (max.) F_{ax} Lbf	Surface pressures on		Tightening screws		Weight (approx.) Lb
dxD mm	d inch	D inch	L1 inch	L2 inch	B inch			p_s psi	p_h psi	DIN 912 12.9 n x type	Tightening torque M_s Lb-ft	
70 x 110	2.756	4.331	1.969	2.362	2.756	3083	26977	16389	9282	8 x M10	36	5
80 x 120	3.150	4.724	1.969	2.362	2.756	4411	33722	17985	10588	10 x M10	36	6
90 x 130	3.543	5.118	1.969	2.362	2.756	5458	37094	17550	10878	11 x M10	36	6
100 x 145	3.937	5.709	2.362	2.756	3.228	8062	49233	17550	10733	10 x M12	63	9
110 x 155	4.331	6.102	2.362	2.756	3.228	8851	49233	15954	10008	10 x M12	63	10
120 x 165	4.724	6.496	2.362	2.756	3.228	10621	54179	16099	10443	11 x M12	63	11
130 x 180	5.118	7.087	2.559	3.110	3.583	14677	68792	17114	11168	14 x M12	63	14
140 x 190	5.512	7.480	2.559	3.110	3.583	16890	73738	16969	11313	15 x M12	63	15
150 x 200	5.906	7.874	2.559	3.110	3.583	18144	73738	15954	10733	15 x M12	63	17
160 x 210	6.299	8.268	2.559	3.110	3.583	20652	78684	15954	10878	16 x M12	63	16
170 x 225	6.693	8.858	3.071	3.622	4.173	27880	100265	15809	10733	15 x M14	100	24
180 x 235	7.087	9.252	3.071	3.622	4.173	29576	100265	14939	10298	15 x M14	100	25
190 x 250	7.480	9.843	3.465	4.016	4.567	33264	106785	13053	8992	16 x M14	100	32
200 x 260	7.874	10.236	3.465	4.016	4.567	39386	120273	13924	9718	18 x M14	100	34
220 x 285	8.661	11.220	3.780	4.252	4.882	50597	140281	13634	9572	15 x M16	155	45
240 x 305	9.449	12.008	3.780	4.252	4.882	73608	187042	16679	11893	20 x M16	155	48
260 x 325	10.236	12.795	3.780	4.252	4.882	79656	187042	15374	11168	20 x M16	155	52
280 x 355	11.024	13.976	3.780	4.331	5.118	101046	220089	17695	12328	15 x M20	302	66
300 x 375	11.811	14.764	3.780	4.331	5.118	115059	234702	17550	12473	16 x M20	302	69
320 x 405	12.598	15.945	4.882	5.354	6.142	153412	293377	15084	10878	20 x M20	302	106
340 x 425	13.386	16.732	4.882	5.354	6.142	163001	293377	14214	10298	20 x M20	302	112
360 x 455	14.173	17.913	5.512	6.102	6.968	214630	363518	14649	10588	20 x M22	406	152
380 x 475	14.961	18.701	5.512	6.102	6.968	226431	363518	13924	10153	20 x M22	406	161
400 x 495	15.748	19.488	5.512	6.102	6.968	261834	399712	14504	10733	22 x M22	406	168
420 x 515	16.535	20.276	5.512	6.102	6.968	300187	436131	15084	11168	24 x M22	406	176
440 x 535	17.323	21.063	5.512	6.102	6.968	314201	436131	14359	10878	24 x M22	406	179
460 x 555	18.110	21.850	5.512	6.102	6.968	328952	436131	13779	10443	24 x M22	406	187
480 x 575	18.898	22.638	5.512	6.102	6.968	357717	454341	13779	10443	25 x M22	406	194
500 x 595	19.685	23.425	5.512	6.102	6.968	372468	454341	13198	10153	25 x M22	406	201
520 x 615	20.472	24.213	5.512	6.102	6.968	433685	508745	14214	11023	28 x M22	406	209
540 x 635	21.260	25.000	5.512	6.102	6.968	450649	508745	13634	10588	28 x M22	406	216
560 x 655	22.047	25.787	5.512	6.102	6.968	500803	545164	14069	11023	30 x M22	406	223
580 x 675	22.835	26.575	5.512	6.102	6.968	518505	545164	13634	10733	30 x M22	406	229
600 x 695	23.622	27.362	5.512	6.102	6.968	536206	545164	13198	10443	30 x M22	406	238

For larger diameter or inch series please contact us.

TLK 452

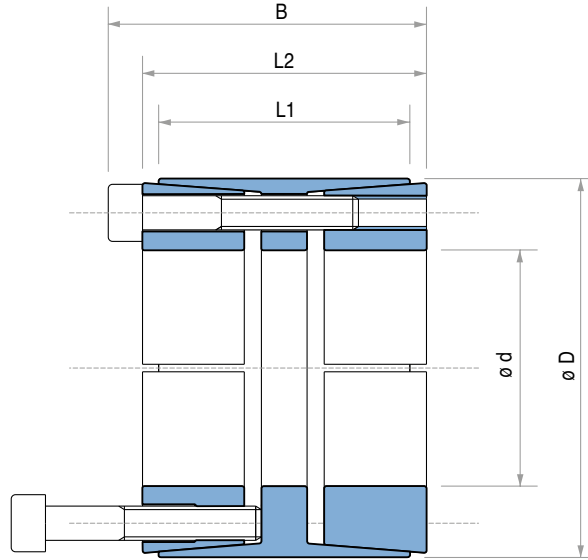

TLK 452 DIMENSIONS

d	d	D	Dimensions			Torque (max.) M _t	Axial Thrust (max.) F _{ax}	Surface pressures on		Tightening screws		Weight (approx.) Lb
			L1	L2	B			Shaft p _s	Hub p _h	DIN 912 12.9 n x type	Tightening torque M _s	
inch	inch	inch	inch	inch	inch	Lb-ft	Lbf	psi	psi		Lb-ft	
1	1,0000	2,165	1,260	1,575	1,811	649	15603	43803	15172	6 x M6	13	1,0
1 1/8	1,1250	2,165	1,260	1,575	1,811	730	15603	38936	15172	6 x M6	13	1,0
1 3/16	1,1880	2,165	1,260	1,575	1,811	767	15603	36872	15172	6 x M6	13	0,9
1 1/4	1,2500	2,362	1,732	2,126	2,362	944	18204	28859	11800	7 x M6	13	1,5
1 3/8	1,3750	2,362	1,732	2,126	2,362	1040	18204	26235	11800	7 x M6	13	1,4
1 7/16	1,4380	2,362	1,732	2,126	2,362	1084	18204	25086	11800	7 x M6	13	1,3
1 1/2	1,5000	2,953	1,732	2,126	2,441	2102	33635	44435	17443	7 x M8	30	2,5
1 5/8	1,6250	2,953	1,732	2,126	2,441	2272	33635	41017	17443	7 x M8	30	2,3
1 11/16	1,6875	2,953	1,732	2,126	2,441	2360	33635	39498	17443	7 x M8	30	2,3
1 3/4	1,7500	2,953	1,732	2,126	2,441	2449	33635	38087	17443	7 x M8	30	2,2
1 7/8	1,8750	3,150	2,205	2,520	2,835	3002	38440	30028	14684	8 x M8	30	3,1
1 15/16	1,9380	3,150	2,205	2,520	2,835	3098	38440	29052	14684	8 x M8	30	3,0
2	2,0000	3,150	2,205	2,520	2,835	3201	38440	28151	14684	8 x M8	30	2,9
2 1/8	2,1250	3,346	2,205	2,520	2,835	3828	43245	29807	15548	9 x M8	30	3,3
2 3/16	2,1880	3,346	2,205	2,520	2,835	3939	43245	28949	15548	9 x M8	30	3,1
2 1/4	2,2500	3,543	2,205	2,520	2,835	4499	48050	31279	16315	10 x M8	30	3,7
2 3/8	2,3750	3,543	2,205	2,520	2,835	4750	48050	29633	16315	10 x M8	30	3,4
2 7/16	2,4380	3,740	2,205	2,520	2,835	4875	48050	28867	15457	10 x M8	30	3,9
2 1/2	2,5000	3,740	2,205	2,520	2,835	5001	48050	28151	15457	10 x M8	30	3,8
2 9/16	2,5630	3,740	2,205	2,520	2,835	5126	48050	27459	15457	10 x M8	30	3,6
2 5/8	2,6250	4,331	2,756	3,071	3,465	8342	76294	33763	16957	10 x M10	61	7,2
2 11/16	2,6880	4,331	2,756	3,071	3,465	8541	76294	32971	16957	10 x M10	61	7,0
2 3/4	2,7500	4,331	2,756	3,071	3,465	8740	76294	32228	16957	10 x M10	61	6,8
2 7/8	2,8750	4,331	2,756	3,071	3,465	9138	76294	30827	16957	10 x M10	61	6,4
2 15/16	2,9380	4,724	2,756	3,071	3,465	10267	83924	33182	17098	11 x M10	61	8,3
3	3,0000	4,724	2,756	3,071	3,465	10488	83924	32497	17098	11 x M10	61	8,1
3 1/8	3,1250	4,724	2,756	3,071	3,465	10923	83924	31197	17098	11 x M10	61	7,7
3 1/4	3,2500	4,724	2,756	3,071	3,465	11358	83924	29997	17098	11 x M10	61	7,2
3 3/8	3,3750	5,118	2,756	3,071	3,465	12870	91553	31512	17217	12 x M10	61	9,0
3 7/16	3,4380	5,118	2,756	3,071	3,465	13114	91553	30934	17217	12 x M10	61	8,8
3 1/2	3,5000	5,118	2,756	3,071	3,465	13350	91553	30386	17217	12 x M10	61	8,5
3 5/8	3,6250	5,118	2,756	3,071	3,465	13822	91553	29339	17217	12 x M10	61	8,0
3 3/4	3,7500	5,709	3,543	3,937	4,409	19088	122191	31363	16024	11 x M12	107	15
3 7/8	3,8750	5,709	3,543	3,937	4,409	19693	122191	30351	16024	11 x M12	107	14
3 15/16	3,9380	5,709	3,543	3,937	4,409	19988	122191	29865	16024	11 x M12	107	13

For larger diameter or inch series please contact us.
 NOTE: it is possible to reduce the screws tightening torque down to 60% of the values indicated in above table;
 as a result M_t, F_{ass}, P_w, P_n are reduced proportionally.

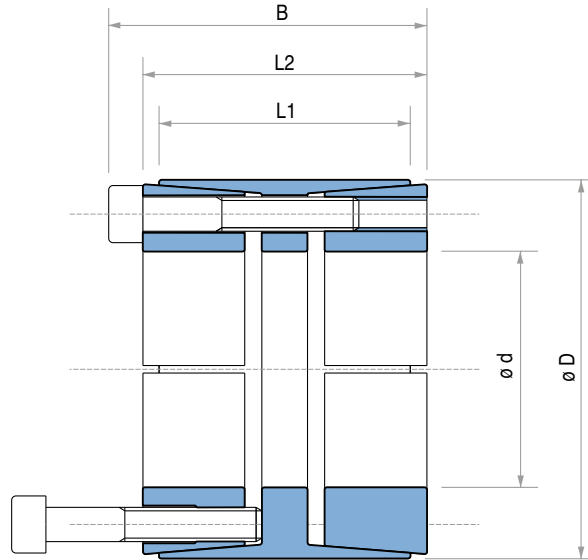

TLK 452 DIMENSIONS

Dimensions						Torque (max.) M_t Lb-ft	Axial Thrust (max.) F_{ax} Lbf	Surface pressures on		Tightening screws		Weight (approx.) Lb
d inch	d inch	D inch	L1 inch	L2 inch	B inch			P_s psi	P_h psi	DIN 912 12.9 n x type	Tightening torque M_s Lb-ft	
4	4,0000	5,709	3,543	3,937	4,409	20357	122191	29403	16024	11 x M12	107	13
4 1/4	4,2500	6,102	3,543	3,937	4,409	23602	133300	30189	16353	12 x M12	107	15
4 3/8	4,3750	6,102	3,543	3,937	4,409	24266	133300	29326	16353	12 x M12	107	14
4 7/16	4,4380	6,496	3,543	3,937	4,409	28691	155516	33728	17922	14 x M12	107	18
4 1/2	4,5000	6,496	3,543	3,937	4,409	29134	155516	33263	17922	14 x M12	107	17
4 3/4	4,7500	6,496	3,543	3,937	4,409	30756	155516	31513	17922	14 x M12	107	15
4 15/16	4,9380	7,087	4,094	4,567	5,118	37616	182899	29709	16720	12 x M14	170	23
5	5,0000	7,087	4,094	4,567	5,118	38058	182899	29340	16720	12 x M14	170	23
5 1/4	5,2500	7,480	4,094	4,567	5,118	46614	213383	32600	18480	14 x M14	170	26
5 7/16	5,4380	7,480	4,094	4,567	5,118	48310	213383	31473	18480	14 x M14	170	24
5 1/2	5,5000	7,480	4,094	4,567	5,118	48827	213383	31119	18480	14 x M14	170	23
5 3/4	5,7500	7,874	4,094	4,567	5,118	54727	228624	31892	18810	15 x M14	170	26
5 15/16	5,9380	7,874	4,094	4,567	5,118	56497	228624	30882	18810	15 x M14	170	24
6	6,0000	8,268	4,094	4,567	5,118	60923	243866	32600	19109	16 x M14	170	29
6 7/16	6,4380	8,858	5,276	5,827	6,457	79509	296566	29559	16833	14 x M16	262	43
6 1/2	6,5000	8,858	5,276	5,827	6,457	80247	296566	29277	16833	14 x M16	262	42
6 15/16	6,9380	9,252	5,276	5,827	6,457	91826	317749	29388	17268	15 x M16	262	44
7	7,0000	9,252	5,276	5,827	6,457	92638	317749	29127	17268	15 x M16	262	43
7 1/4	7,2500	9,843	5,276	5,827	6,457	102374	338932	29998	17314	16 x M16	262	52
7 7/16	7,4380	9,843	5,276	5,827	6,457	105029	338932	29240	17314	16 x M16	262	49
7 1/2	7,5000	9,843	5,276	5,827	6,457	105914	338932	28998	17314	16 x M16	262	47
7 3/4	7,7500	10,236	5,276	5,827	6,457	109380	338932	28062	16648	16 x M16	262	52
7 15/16	7,9380	10,236	5,276	5,827	6,457	112036	338932	27398	16648	16 x M16	262	49
8	8,0000	10,236	5,276	5,827	6,457	112921	338932	27185	16648	16 x M16	262	48

For larger diameter or inch series please contact us.

NOTE: it is possible to reduce the screws tightening torque down to 60% of the values indicated in above table; as a result M_t , F_{ax} , P_w , P_n are reduced proportionally.

TLK 500

TLK 500 DIMENSIONS

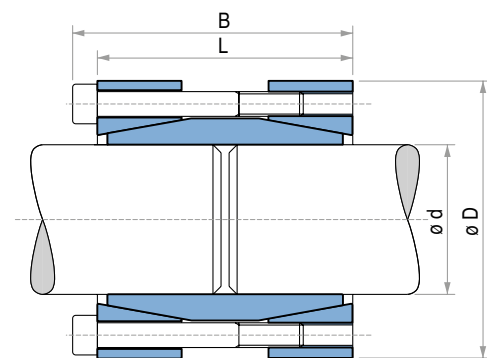

Standard version

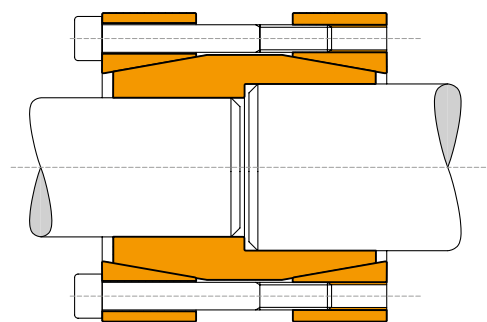

Double diameter versions are available

dxD mm	d inch	D inch	L inch	B inch	M _t Lb-ft	F _{ax} Lbf	Tightening screws		Weight (approx.)
							DIN 912 12.9	Tightening Torque	
14 x 45	0.551	1.772	1.969	2.205	125	5395	4 x M6	13	1
15 x 45	0.591	1.772	1.969	2.205	133	5395	4 x M6	13	1
16 x 45	0.630	1.772	1.969	2.205	140	5395	4 x M6	13	1
17 x 50	0.669	1.969	1.969	2.205	148	5395	4 x M6	13	1
18 x 50	0.709	1.969	1.969	2.205	162	5395	4 x M6	13	1
19 x 50	0.748	1.969	1.969	2.205	170	5395	4 x M6	13	1
20 x 50	0.787	1.969	1.969	2.205	177	5395	4 x M6	13	1
22 x 55	0.866	2.165	2.362	2.598	192	5395	4 x M6	13	1
24 x 55	0.945	2.165	2.362	2.598	214	5395	4 x M6	13	1
25 x 55	0.984	2.165	2.362	2.598	332	8318	6 x M6	13	1
28 x 60	1.102	2.362	2.362	2.598	376	8318	6 x M6	13	2
30 x 60	1.181	2.362	2.362	2.598	406	8318	6 x M6	13	2
32 x 75	1.260	2.953	2.362	2.677	531	10116	4 x M8	30	3
35 x 75	1.378	2.953	2.953	3.268	583	10116	4 x M8	30	3
38 x 75	1.496	2.953	2.953	3.268	627	10116	4 x M8	30	3
40 x 75	1.575	2.953	2.953	3.268	664	10116	4 x M8	30	3
42 x 90	1.654	3.543	2.953	3.268	1033	15287	6 x M8	30	6
45 x 90	1.772	3.543	3.346	3.661	1121	15287	6 x M8	30	6
48 x 90	1.890	3.543	3.346	3.661	1195	15287	6 x M8	30	5
50 x 90	1.969	3.543	3.346	3.661	1246	15287	6 x M8	30	5
55 x 105	2.165	4.134	3.346	3.661	1822	20233	8 x M8	30	7
60 x 105	2.362	4.134	3.346	3.661	1999	20233	8 x M8	30	7
65 x 105	2.559	4.134	3.346	3.661	2161	20233	8 x M8	30	7
70 x 125	2.756	4.921	3.937	4.331	2781	24279	6 x M10	61	12
75 x 125	2.953	4.921	3.937	4.331	2972	24279	6 x M10	61	11
80 x 125	3.150	4.921	3.937	4.331	3172	24279	6 x M10	61	10

For larger diameter or inch series please contact us.

Characteristics

- Medium high torque
- Less number of tightening screws
- Easy installation
- Application economically advantageous

Installation

Carefully clean the shafts contact surfaces. Fit the rigid coupling at the end of the connecting shafts. Tighten gradually and regularly in crossed sequence all screws to reach the tightening torque M_s indicated on the table.

Dismantling

By loosening all tightening screws the clamping cones are normally released. However in case of difficulties slightly hammer the released screws in a way to push back the rear pressure cone.

Tolerances, surface finish

A good surface finish by the machine tool is sufficient.

Maximum allowable surface finish:

Rt max 16 μm (Ra 3 μm - Rz 13 μm)

Maximum permissible tolerances:

h8 for shaft

For exact tolerance values see page 57.

TLK 603 TLK 602 TLK 601

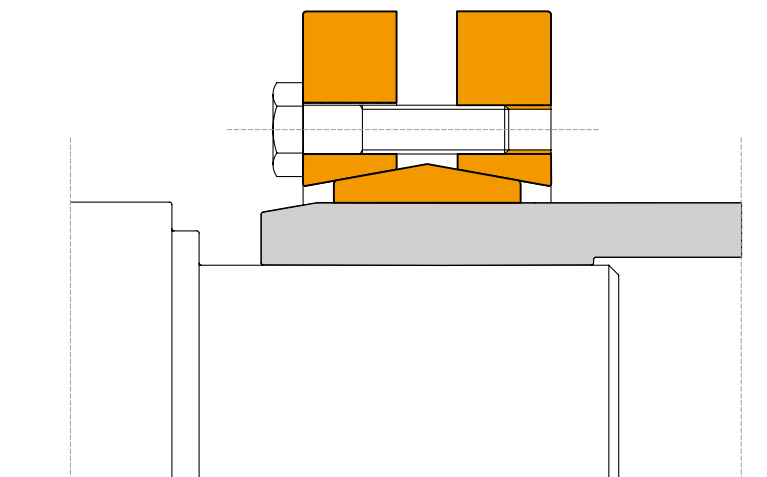

Characteristics

- Medium-high torque
- No shaft-hub axial movement
- Quick installation time
- Low inertia

Installation

Carefully clean the hub and shaft contact surfaces. Slide the shrink disc outside the hollow shaft. Tighten gradually and regularly in continuous sequence all screws to reach the tightening torque M_s indicated in the table.

To reach the required tightening torque M_s it is necessary to repeat the procedure more than once.

Do not use **molybdenum bisulphide** in the hub and shaft contact surfaces.

Dismantling

Loosen the clamping screws in a continuous and gradual sequence. Do not remove screws from threads. Normally with this operation the shrink disc is released.

In case of reuse, apply a solid lubricant (that can guarantee a friction coefficient equal to 0,04) in the screws and in the tapered surfaces.

Tolerances, surface finish

A good surface finish by the machine tool is sufficient.

Maximum allowable surface finish:

Rt max 16 μm (Ra 3 μm - Rz 13 μm)

Maximum permissible tolerances:

d = h8 for hub o.d.

Dw diameter tolerances

From 0.4 to 1.2 inch	H6/j6
From 1.2 to 2.0 inch	H6/h6
From 2.0 to 3.2 inch	H6/g6
From 3.2 to 19.7 inch	H7/g6

For exact tolerance values see page 57.

Axial movement

During screws tightening the hub has no axial movement with respect to the shaft.

TLK 603

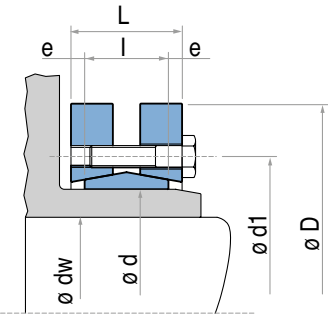

TLK 603 DIMENSIONS

Type	Customer Shaft diameter		Torque (max.)	Axial Thrust (max.)						Tightening screws DIN 931-10.9	Tightening Torque	Weight (approx.)
	d mm	d inch	M _t Lb-ft	F _{ax} Lbf	D inch	I inch	L inch	d1 inch	e inch	n x type	M _s Lb-ft	Lb
14	0.551	0.433	22	1349	1.496	0.276	0.433	0.906	0.079	4 x M5*	3	0.2
		0.472	37	2023								
16	0.630	0.512	52	2248	1.614	0.433	0.591	1.024	0.079	5 x M5*	3	0.2
		0.551	66	2923								
18	0.709	0.591	66	2698	1.693	0.433	0.591	1.102	0.079	5 x M5*	3	0.2
		0.630	77	2923								
24	0.945	0.748	125	5620	1.969	0.551	0.768	1.417	0.108	6 x M5*	3	0.4
		0.787	155	6070								
		0.827	184	6519								
30	1.181	0.945	221	6519	2.362	0.630	0.846	1.732	0.108	7 x M5*	3	0.7
		0.984	251	6969								
		1.024	280	7419								
36	1.417	1.102	325	11241	2.835	0.709	0.925	2.047	0.108	5 x M6	9	1
		1.181	420	13039								
		1.220	465	13039								
44	1.732	1.260	457	14388	3.150	0.787	1.004	2.402	0.108	7 x M6	9	1
		1.378	575	16636								
		1.417	634	17310								
50	1.969	1.496	693	17760	3.543	0.866	1.083	2.756	0.108	8 x M6	9	2
		1.575	856	19334								
		1.654	1018	20683								
55	2.165	1.654	856	17760	3.937	0.906	1.201	2.953	0.148	8 x M6	9	2
		1.772	1121	19783								
		1.890	1387	21807								
62	2.441	1.890	1364	22481	4.331	0.906	1.201	3.386	0.148	10 x M6	9	3
		1.969	1623	24954								
		2.047	1770	26303								
68	2.677	1.969	1475	21807	4.528	0.906	1.201	3.386	0.148	10 x M6	9	3
		2.165	1844	23830								
		2.362	2323	26977								
75	2.953	2.165	1844	26752	5.433	0.984	1.280	3.937	0.148	7 x M8	22	4
		2.362	2360	30799								
		2.559	2913	34846								
80	3.150	2.362	2360	27876	5.709	0.984	1.280	3.937	0.148	7 x M8	22	4
		2.559	2876	31473								
		2.756	3393	35520								
85	3.346	2.559	3540	39342	6.102	1.181	1.535	4.488	0.177	10 x M8	22	8
		2.756	4499	43838								
		2.953	5458	48559								
90	3.543	2.559	3503	38218	6.102	1.181	1.535	4.488	0.177	10 x M8	22	7
		2.756	4425	42714								
		2.953	5347	47210								
100	3.937	2.756	5089	43838	6.693	1.339	1.732	4.882	0.197	12 x M8	22	10
		2.953	5532	49458								
		3.150	6638	53954								
110	4.331	2.953	5310	51481	7.283	1.535	1.969	5.354	0.217	9 x M10	44	13
		3.150	6638	56652								
		3.346	7966	58900								
115	4.528	3.150	5458	52830	7.402	1.535	1.969	5.551	0.217	9 x M10	44	12
		3.346	6786	58226								
		3.543	8187	60474								
120	4.724	3.150	7818	64071	8.465	1.654	2.126	6.299	0.236	12 x M10	44	20
		3.346	9810	70590								
		3.543	10695	76435								
125	4.921	3.346	8113	66544	8.465	1.654	2.126	6.299	0.236	12 x M10	44	18
		3.543	9588	72838								
		3.740	11063	79133								
130	5.118	3.543	8334	68342	8.465	1.654	2.126	6.299	0.236	12 x M10	44	18
		3.740	9810	74862								
		3.937	11358	81381								
140	5.512	3.740	11137	82505	9.055	1.811	2.382	6.890	0.285	10 x M12	74	22
		3.937	12981	89025								
		4.134	14825	95544								
155	6.102	4.134	16226	100490	10.433	1.969	2.539	7.559	0.285	12 x M12	74	33
		4.331	18439	107459								
		4.528	20652	114428								
160	6.299	4.331	16669	103413	10.433	1.969	2.539	7.559	0.285	12 x M12	74	32
		4.528	18955	110157								
		4.724	21242	116901								
165	6.496	4.528	22864	133762	11.417	2.205	2.795	8.268	0.295	8 x M16	184	49
		4.724	25815	141630								
		4.921	28765	147251								

For larger diameter please contact our application engineering department.

TLK 603

Type		Customer Shaft diameter	Torque (max.)	Axial Thrust (max.)						Tightening screws DIN 931-10.9	Tightening Torque	Weight (approx.)
d mm	d inch	dw inch	M _t Lb-ft	F _{ax} Lbf	D inch	l inch	L inch	d1 inch	e inch	n x type	M _t Lb-ft	Lb
170	6.693	4.724	23528	137134	11.417	2.205	2.795	8.268	0.295	8 x M16	184	46
		4.921	26552	143878								
		5.118	29576	150623								
175	6.890	4.921	26552	136010	11.811	2.205	2.795	8.661	0.295	8 x M16	184	49
		5.118	30240	143654								
		5.315	33190	151747								
180	7.087	5.118	27290	179848	11.811	2.205	2.795	8.661	0.295	8 x M16	184	46
		5.315	31125	188840								
		5.512	34149	198957								
185	7.283	5.315	38353	174902	12.992	2.795	3.386	9.291	0.295	10 x M16	184	82
		5.512	42041	184119								
		5.709	45729	193561								
190	7.480	5.512	39459	179848	12.992	2.795	3.386	9.291	0.295	10 x M16	184	79
		5.709	43295	188840								
		5.906	47056	198957								
195	7.677	5.512	47941	209748	13.780	2.795	3.386	9.685	0.295	12 x M16	184	90
		5.906	54579	222562								
		6.102	60111	240772								
200	7.874	5.906	54579	222562	13.780	2.795	3.386	9.685	0.295	12 x M16	184	90
		6.102	59005	232678								
		6.299	63430	242795								
220	8.661	6.299	70068	267524	14.567	3.465	4.094	10.630	0.315	15 x M16	184	119
		6.496	75231	278540								
		6.693	81132	290005								
240	9.449	6.693	88507	329122	15.945	3.622	4.291	11.614	0.335	12 x M20	361	148
		7.087	101783	354301								
		7.480	115059	376557								
260	10.236	7.480	120960	395666	16.929	4.055	4.724	12.638	0.335	14 x M20	361	181
		7.874	135711	422643								
		8.268	151200	451868								
280	11.024	8.268	160051	469853	18.110	4.488	5.276	13.622	0.394	16 x M20	361	225
		8.661	179965	499078								
		9.055	199141	528304								
300	11.811	9.055	202829	546513	19.094	4.803	5.591	14.331	0.394	18 x M20	361	260
		9.449	217580	577087								
		9.646	232331	592599								
320	12.598	9.449	230119	595072	20.472	4.803	5.591	15.197	0.394	20 x M20	361	289
		9.843	250770	626321								
		10.236	275847	651949								
340	13.386	9.843	287648	701182	22.441	5.276	6.142	16.063	0.433	24 x M20	361	410
		10.236	311619	730408								
		10.630	339278	764354								
350	13.780	10.630	326002	736478	22.835	5.512	6.378	17.008	0.433	24 x M20	361	430
		11.024	354029	771098								
		11.220	368780	786835								
360	14.173	11.024	341490	744121	23.228	5.512	6.378	17.008	0.433	24 x M20	361	450
		11.417	370255	778067								
		11.614	385006	794928								
380	14.961	11.417	418197	879007	25.394	5.669	6.614	18.031	0.472	20 x M24	620	527
		11.811	449912	917225								
		12.205	485314	954993								
390	15.354	11.811	460237	935210	25.984	5.669	6.614	18.425	0.472	21 x M24	620	573
		12.205	494903	973427								
		12.598	529568	1008048								
400	15.748	12.402	494165	957691	26.772	5.669	6.614	18.898	0.472	21 x M24	620	617
		12.598	512604	976799								
		12.992	548745	1011645								
420	16.535	12.992	575297	1090329	27.165	6.457	7.402	19.842	0.472	24 x M24	620	697
		13.386	619550	1133042								
		13.780	663804	1173508								
440	17.323	13.386	594473	1065599	29.528	6.968	7.953	20.748	0.492	24 x M24	620	899
		13.780	634302	1103817								
		14.173	676343	1144283								
460	18.110	14.173	737560	1274673	30.315	6.968	7.953	21.535	0.492	28 x M24	620	926
		14.567	789189	1317387								
		14.961	840818	1360101								
480	18.898	14.961	862945	1382582	31.496	7.402	8.386	22.441	0.492	30 x M24	620	1113
		15.354	914574	1427544								
		15.748	966204	1472506								

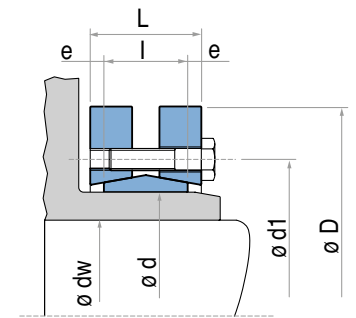

For larger diameter please contact our application engineering department.

TLK 602

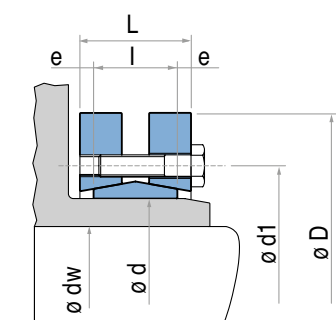

TLK 602 DIMENSIONS

Type	Customer Shaft diameter	Torque (max.)	Axial Thrust (max.)	Tightening screws DIN 931-10.9	Tightening Torque	Weight (approx.)						
d mm	d inch	dw inch	M _t Lb-ft	F _{ax} Lbf	D inch	I inch	L inch	d1 inch	e inch	n x type	M _s Lb-ft	Lb
125	4.921	3.346	11063	79808	8.465	2.165	2.559	6.299	0.197	10 x M12	74	24
		3.543	12907	87226								
		3.740	14751	94870								
140	5.512	3.740	15194	97343	9.055	2.362	2.913	6.890	0.276	12 x M12	74	29
		3.937	17333	105436								
		4.134	19545	112405								
155	6.102	4.134	21094	123646	10.433	2.598	3.150	7.795	0.276	15 x M12	74	44
		4.331	23971	132638								
		4.528	26847	141630								
165	6.496	4.528	30240	166359	11.417	2.835	3.465	8.268	0.315	10 x M16	184	57
		4.724	33928	176476								
		4.921	37394	183220								
175	6.890	4.921	34665	168608	11.811	2.835	3.465	8.661	0.315	10 x M16	184	64
		5.118	38353	178724								
		5.315	42041	188840								
185	7.283	5.315	53104	247291	12.992	3.622	4.409	9.291	0.394	14 x M16	184	104
		5.512	57530	258532								
		5.709	63430	269772								
195	7.677	5.709	55317	241671	13.780	3.622	4.409	9.685	0.394	14 x M16	184	117
		5.906	64905	265276								
		6.102	70806	277640								
200	7.874	5.709	62693	263028	13.780	3.622	4.409	9.685	0.394	15 x M16	184	110
		5.906	68224	276516								
		6.102	73756	290005								
220	8.661	6.299	93670	357448	14.567	4.488	5.276	10.630	0.394	20 x M16	184	143
		6.496	100308	370937								
		6.693	108053	386673								
240	9.449	6.693	114322	409154	15.945	4.724	5.669	11.614	0.472	15 x M20	361	192
		7.087	129811	440628								
		7.480	146037	467605								
260	10.236	7.480	157100	508071	16.929	5.354	6.299	12.638	0.472	18 x M20	361	220
		7.874	177014	544040								
		8.268	197666	580010								
280	11.024	8.268	210205	615979	18.110	5.827	6.772	13.622	0.472	21 x M20	361	291
		8.661	236019	654197								
		9.055	261834	694663								
300	11.811	9.055	251508	665438	19.094	5.984	6.929	14.331	0.472	22 x M20	361	309
		9.449	277323	703655								
		9.646	290599	722764								
320	12.598	9.449	278798	708152	20.472	6.299	7.244	15.197	0.472	24 x M20	361	364
		9.843	306087	747493								
		10.236	332640	780091								
340	13.386	9.843	361036	879007	22.441	6.929	7.874	16.535	0.472	21 x M24	620	529
		10.236	390907	916101								
		10.630	426310	961063								
350	13.780	10.630	410083	926667	22.835	6.929	7.874	16.732	0.472	21 x M24	620	545
		11.024	445486	971179								
		11.220	463925	992536								
360	14.173	11.024	451387	982420	23.228	7.087	8.031	17.008	0.472	22 x M24	620	551
		11.417	489002	1027382								
		11.614	508179	1049863								
380	14.961	11.417	455812	959939	25.394	7.087	8.031	18.031	0.472	22 x M24	620	705
		11.811	492690	1001529								
		12.205	530306	1044242								
390	15.354	11.811	522192	1059979	25.984	7.402	8.346	18.425	0.472	24 x M24	620	772
		12.205	562021	1103817								
		12.598	600743	1144283								
400	15.748	12.402	564233	1091453	26.772	7.402	8.346	18.898	0.472	24 x M24	620	816
		12.598	581197	1107639								
		12.992	623238	1152151								
420	16.535	12.992	736822	1361225	27.165	8.425	9.370	19.842	0.472	30 x M24	620	904
		13.386	787714	1412931								
		13.780	840818	1464637								
440	17.323	13.386	780338	1400566	29.528	8.819	9.921	20.748	0.551	24 x M27	922	1157
		13.780	833443	1452273								
		14.173	888022	1503979								
460	18.110	14.173	973579	1672586	30.315	8.819	9.921	21.535	0.551	28 x M27	922	1190
		14.567	1047335	1731037								
		14.961	1106340	1787240								

For larger diameter please contact our application engineering department.

TLK 601

Type	Customer Shaft diameter		Torque (max.)		Axial Thrust (max.)					Tightening screws DIN 931-10.9	Tightening Torque	Weight (approx.)
d mm	d inch	dw inch	M _t Lb-ft	F _{ax} Lbf	D inch	l inch	L inch	d1 inch	e inch	n x type	M _t Lb-ft	Lb
125	4.921	3.740	7781	49458	7.283	1.535	2.008	6.220	0.236	8 x M10	44	13
		3.937	8924	53954								
		4.134	10178	58451								
140	5.512	4.331	10916	59575	8.661	1.535	2.008	6.890	0.236	9 x M10	44	18
		4.724	13748	69691								
		4.921	15120	73063								
155	6.102	5.118	17701	82056	9.646	1.535	2.008	7.559	0.236	11 x M10	44	22
		5.315	19472	87676								
		5.512	21389	92172								
165	6.496	5.315	23602	106785	10.236	1.811	2.441	8.268	0.315	10 x M12	74	31
		5.512	25962	112405								
		5.709	28396	119149								
175	6.890	5.709	28765	120273	10.827	1.811	2.441	8.661	0.315	11 x M12	74	35
		5.906	31273	125894								
		6.102	33928	132638								
185	7.283	6.102	34370	134886	11.614	1.811	2.441	8.858	0.315	12 x M12	74	44
		6.299	37099	140506								
		6.496	39828	146127								
195	7.677	6.496	46466	170856	12.402	2.205	2.835	9.331	0.315	15 x M12	74	60
		6.693	49933	178724								
		6.890	53473	185468								
200	7.874	6.890	54579	191089	12.992	2.205	2.835	9.528	0.315	16 x M12	74	66
		7.087	58636	200081								
		7.283	62324	205701								
220	8.661	7.087	61070	206825	13.583	2.598	3.307	10.433	0.354	10 x M16	184	77
		7.480	68962	220314								
		7.874	77444	237175								
240	9.449	7.874	83344	255159	14.567	2.598	3.307	11.417	0.354	12 x M16	184	97
		8.268	94039	272020								
		8.465	99202	281013								
260	10.236	8.661	109896	303494	15.551	2.835	3.622	12.205	0.394	14 x M16	184	106
		9.055	121697	322602								
		9.252	127598	331595								
280	11.024	9.055	126123	333843	16.732	3.307	4.094	13.110	0.394	16 x M16	184	132
		9.449	139399	352952								
		9.843	153412	373185								
300	11.811	9.843	158575	386673	18.110	3.307	4.094	14.094	0.394	18 x M16	184	165
		10.236	172589	404658								
		10.630	188078	424891								
320	12.598	10.630	191766	436131	19.488	3.307	4.173	14.882	0.433	20 x M16	184	185
		11.024	209467	456364								
		11.417	225693	477721								
340	13.386	11.417	221268	465357	21.063	3.307	4.173	15.827	0.433	21 x M16	184	220
		11.811	239264	485590								
		12.008	248558	496830								
350	13.780	11.811	274372	558653	21.457	3.937	4.803	16.260	0.433	16 x M20	361	265
		12.008	283961	571017								
		12.205	295024	582258								
360	14.173	11.811	265522	539544	21.850	3.937	4.803	16.654	0.433	16 x M20	361	276
		12.205	286173	562025								
		12.598	306087	582258								
380	14.961	12.598	320839	611483	23.031	4.409	5.354	17.402	0.472	18 x M20	361	331
		12.795	332640	624972								
		12.992	344441	637336								
390	15.354	12.992	372468	687919	23.425	4.409	5.354	17.795	0.472	20 x M20	361	344
		13.386	398282	713772								
		13.780	425572	740749								
400	15.748	13.386	405658	727260	24.213	4.409	5.354	18.189	0.472	21 x M20	361	375
		13.780	432948	755362								
		14.173	461713	782339								
420	16.535	13.780	426310	741873	24.803	4.724	5.669	19.094	0.472	22 x M20	361	408
		14.173	455075	769974								
		14.567	483102	796951								
440	17.323	14.567	499328	822805	25.984	4.724	5.669	19.882	0.472	24 x M20	361	452
		14.961	530306	850906								
		15.354	562021	879007								
460	18.110	15.354	619550	971179	26.968	5.197	6.220	20.748	0.512	28 x M20	361	518
		15.748	656428	1002653								
		16.142	689619	1029630								

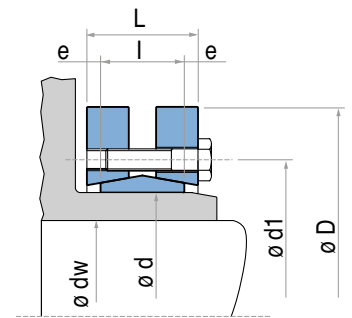

For larger diameter please contact our application engineering department.

TLK 603

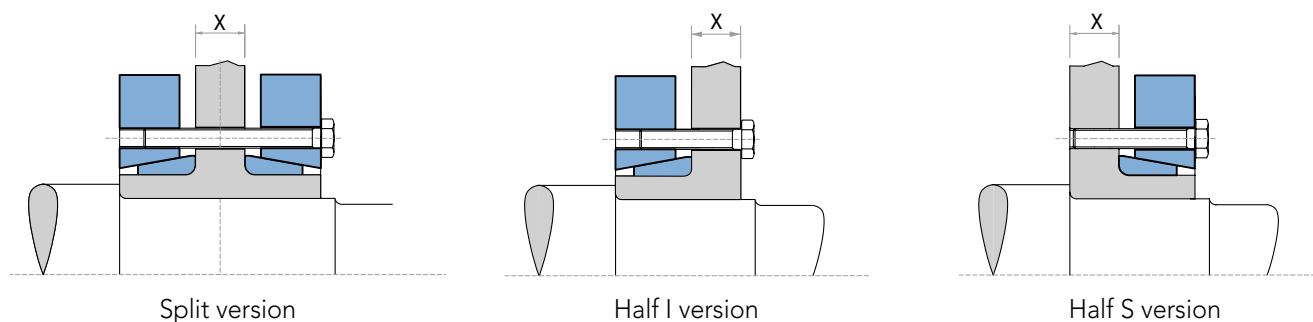

When ordering please specify X dimension

Characteristics

- Medium-high torque
- No shaft-hub axial movement
- Quick installation time
- Low inertia

Installation

Carefully clean the hub and shaft contact surfaces and apply a thin film of light-weight oil. Slide the shrink disc outside the hollow shaft. Tighten gradually and regularly in continuous sequence all screws to reach the tightening torque M_s indicated in the rating table. To reach the required tightening torque M_s it is necessary to repeat the procedure more than once.

Do not use grease with **molybdenum bisulphide** in the hub and shaft contact surfaces. Performances shown in the rating tables are calculated in the case of mounting with oil. Performances are increased when dry mounting. For any further information please contact our engineering department.

Torque capacities for half versions are = $M_t / 2$.

Dismantling

Loosen the clamping screws in a continuous and gradual sequence. Do not remove screws from threads.

Normally with this operation the shrink disc is released. In case of reuse, apply a solid lubricant (that can provide a coefficient of friction around 0.04) in the screws and in the tapered surfaces.

Tolerances, surface finish

A good surface finish by the machine tool is sufficient.

Maximum allowable surface finish:

Rt max 16 μm (Ra 3 μm - Rz 13 μm)

Maximum permissible tolerances:

d = h8 for hub o.d.

For exact tolerance values see page 57.

DW diameter tolerance

From 0.4 to 1.2 inch	H6/j6
From 1.2 to 2.0 inch	H6/h6
From 2.0 to 3.2 inch	H6/g6
From 3.2 to 19.7 inch	H7/g6

For exact tolerance values see page 57.

Axial movement

During tightening of mounting screw the hub has no axial movement with respect to the shaft.

TLK 603

Type	Customer Shaft diameter		Torque (max.)	Axial Thrust (max.)						Tightening screws DIN 931-10.9	Tightening Torque
d mm	d inch	dw inch	M _t Lb-ft	F _{ax} Lbf	D inch	l inch	L inch	d1 inch	e inch	n x type	M _t Lb-ft
24	0.945	0.787	155	6070	1.969	0.354	0.453	1.417	0.059	6 x M5*	3
30	1.181	0.984	251	6969	2.362	0.394	0.492	1.732	0.059	7 x M5*	3
36	1.417	1.181	420	13039	2.835	0.433	0.531	2.047	0.059	5 x M6	9
44	1.732	1.378	575	16636	3.150	0.492	0.591	2.402	0.098	7 x M6	9
50	1.969	1.575	856	19334	3.543	0.531	0.630	2.756	0.098	8 x M6	9
55	2.165	1.772	1121	19783	3.937	0.551	0.689	2.953	0.098	8 x M6	9
62	2.441	1.969	1623	24954	4.331	0.551	0.689	3.386	0.098	10 x M6	9
68	2.677	2.165	1844	23830	4.528	0.551	0.689	3.386	0.098	10 x M6	9
75	2.953	2.362	2360	30799	5.433	0.630	0.768	3.937	0.118	7 x M8	22
80	3.150	2.559	2876	31473	5.709	0.630	0.768	3.937	0.118	7 x M8	22
85	3.346	2.756	4499	43838	6.102	0.728	0.906	4.488	0.138	10 x M8	22
90	3.543	2.756	4425	42714	6.102	0.728	0.906	4.488	0.138	10 x M8	22
100	3.937	2.953	5532	49458	6.693	0.807	1.004	4.882	0.138	12 x M8	22
110	4.331	3.150	6638	56652	7.283	0.906	1.122	5.354	0.138	9 x M10	44
115	4.528	3.346	6786	58226	7.402	0.906	1.122	5.551	0.138	9 x M10	44
120	4.724	3.346	9810	70590	8.465	1.024	1.260	6.299	0.197	12 x M10	44
125	4.921	3.543	9588	72838	8.465	1.024	1.260	6.299	0.197	12 x M10	44
130	5.118	3.740	9810	74862	8.465	1.024	1.260	6.299	0.197	12 x M10	44
140	5.512	3.937	12981	89025	9.055	1.102	1.378	6.890	0.197	10 x M12	74
155	6.102	4.331	18439	107459	10.433	1.181	1.457	7.559	0.197	12 x M12	74
160	6.299	4.528	18955	110157	10.433	1.181	1.457	7.559	0.197	12 x M12	74
165	6.496	4.724	25815	141630	11.417	1.299	1.594	8.268	0.197	8 x M16	184
170	6.693	4.921	26552	143878	11.417	1.299	1.594	8.268	0.197	8 x M16	184
175	6.890	5.118	30240	143654	11.811	1.299	1.594	8.661	0.197	8 x M16	184
180	7.087	5.315	31125	188840	11.811	1.299	1.594	8.661	0.197	8 x M16	184
185	7.283	5.512	42041	184119	12.992	1.594	1.890	9.291	0.197	10 x M16	184
190	7.480	5.709	43295	188840	12.992	1.594	1.890	9.291	0.197	10 x M16	184
195	7.677	5.906	56055	230430	13.780	1.594	1.890	9.685	0.197	12 x M16	184
200	7.874	6.102	59005	232678	13.780	1.594	1.890	9.685	0.197	12 x M16	184
220	8.661	6.496	75231	278540	14.567	2.028	2.343	10.630	0.295	15 x M16	184
240	9.449	7.087	101783	354301	15.945	2.106	2.441	11.614	0.295	12 x M20	361
260	10.236	7.874	135711	422643	16.929	2.323	2.657	12.638	0.295	14 x M20	361
280	11.024	8.661	179965	499078	18.110	2.579	2.972	13.622	0.335	16 x M20	361
300	11.811	9.449	217580	577087	19.094	2.736	3.130	14.331	0.335	18 x M20	361
320	12.598	9.843	250770	626321	20.472	2.736	3.130	15.197	0.335	20 x M20	361
340	13.386	10.236	311619	730408	22.441	2.972	3.406	16.063	0.335	24 x M20	361
350	13.780	11.024	354029	771098	22.835	3.091	3.524	17.008	0.335	24 x M20	361
360	14.173	11.417	370255	778067	23.228	3.091	3.524	17.008	0.335	24 x M20	361
380	14.961	11.811	449912	917225	25.394	3.169	3.642	18.031	0.335	20 x M24	620
390	15.354	12.205	494903	973427	25.984	3.169	3.642	18.425	0.335	21 x M24	620
400	15.748	12.598	512604	976799	26.772	3.169	3.642	18.898	0.335	21 x M24	620
420	16.535	13.386	619550	1133042	27.165	3.720	4.193	19.842	0.394	24 x M24	620
440	17.323	13.780	634302	1103817	29.528	3.976	4.468	20.748	0.394	24 x M24	620
460	18.110	14.567	789189	1317387	30.315	3.976	4.468	21.535	0.394	28 x M24	620
480	18.898	15.354	914574	1427544	31.496	4.193	4.685	22.441	0.394	30 x M24	620

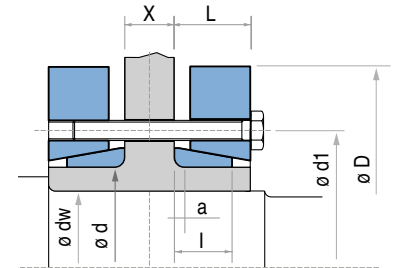

*DIN 931-8.8 screws

TLK 622

TLK 623

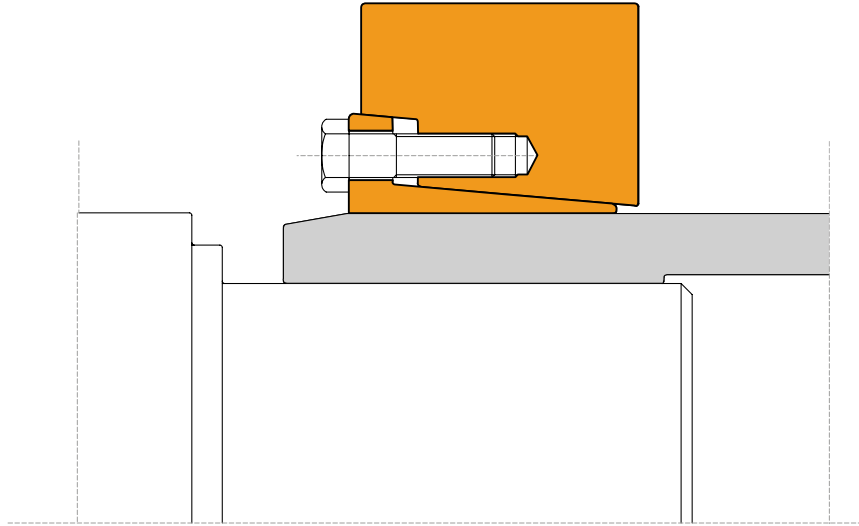

Characteristics

- Very high torques
- No shaft-hub axial movement
- Quick installation time
- Easy dismantling

Installation

Carefully clean the hub and shaft contact surfaces. Slide the shrink disc outside the hollow shaft. Tighten gradually and regularly in continuous sequence all screws to reach the tightening torque M_s indicated in the table. To reach the required tightening torque M_s it is necessary to repeat the procedure more than once.

Do not use grease with **molybdenum bisulphide** in the hub and shaft contact surfaces.

Dismantling

Loosen the clamping screws in a continuous and gradual sequence. Do not remove screws from threads. Normally with this operation the shrink disc is released. In case of reuse, apply a solid lubricant (that can provide a coefficient of friction around 0.04) in the screws and in the tapered surfaces.

Tolerances, surface finish

A good surface finish by the machine tool is sufficient. Maximum allowable surface finish:
Rt max 16 μm (Ra 3 μm - Rz 13 μm)

Maximum permissible tolerances:
d = h7 for hub o.d.

For exact tolerance values see page 57.

DW diameter tolerance

dw: up to 5.9 inch	H7/h6
over 5.9 inch	H7/g6

For exact tolerance values see page 57.

Axial movement

During tightening of mounting screw the hub has no axial movement with respect to the shaft.

TLK 622

Type		Customer Shaft diameter	Torque (max.)	Axial Thrust (max.)						Tightening screws DIN 931-10.9	Tightening Torque	Weight (approx.)
d mm	d inch	dw inch	M _t Lb-ft	F _{ax} Lbf	D inch	l inch	L inch	d1 inch	e inch	type	M _t Lb-ft	Lb
12	0.472	0.354 0.394	15 30	1124 1798	1.378	0.394	0.433	0.945	0.039	M6	9	0.2
14	0.551	0.433 0.472	22 37	1349 2023	1.496	0.394	0.433	1.024	0.039	M6	9	0.2
16	0.630	0.512 0.551	52 66	2248 2923	1.614	0.531	0.591	1.102	0.059	M6	9	0.2
18	0.709	0.591 0.630	59 81	2473 3147	1.732	0.531	0.591	1.181	0.059	M6	9	0.2
20	0.787	0.669 0.709	111 133	4047 4496	1.850	0.531	0.591	1.260	0.059	M6	9	0.2
24	0.945	0.748 0.787 0.866	118 155 207	3822 4496 5620	1.969	0.630	0.709	1.417	0.079	M6	9	0.4
30	1.181	0.945 0.984 1.024	199 236 266	5171 5620 6295	2.362	0.709	0.787	1.732	0.079	M6	9	0.7
36	1.417	1.063 1.181 1.299	325 450 605	7194 9217 11241	2.835	0.787	0.866	2.047	0.079	M8	22	1
44	1.732	1.339 1.378 1.457	509 568 679	9217 9892 11241	3.150	0.866	0.945	2.402	0.079	M8	22	1
50	1.969	1.496 1.575 1.654	819 951 1114	13039 14613 15962	3.543	0.925	1.024	2.677	0.098	M8	22	2
55	2.165	1.654 1.772 1.890	907 1128 1372	13264 15287 17535	3.937	1.024	1.142	2.835	0.118	M8	22	2
62	2.441	1.890 1.969 2.047	1232 1394 1564	15737 17086 18210	4.331	1.024	1.142	3.150	0.118	M8	22	3
68	2.677	1.969 2.165 2.362	1379 1807 2301	16861 20008 23380	4.528	1.024	1.142	3.386	0.118	M8	22	3
75	2.953	2.165 2.362 2.559	1719 2227 2810	19109 22706 26303	5.433	1.063	1.220	3.937	0.157	M10	44	5
80	3.150	2.362 2.559 2.756	2353 2994 3621	23830 27652 31473	5.551	1.063	1.220	4.094	0.157	M10	44	5
90	3.543	2.559 2.756 2.953	3983 4794 5753	37318 42039 46760	6.102	1.339	1.496	4.488	0.157	M10	44	7
100	3.937	2.756 2.953 3.150	4425 5310 6269	38443 43164 47885	6.693	1.535	1.693	4.882	0.157	M10	44	9
110	4.331	3.150 3.346 3.543	7376 8629 10031	55978 61823 67893	7.283	1.713	1.929	5.433	0.217	M12	74	13
120	4.724	3.346 3.543 3.740	8777 10178 11727	62947 69017 75087	7.756	1.831	2.087	5.787	0.256	M12	74	15
125	4.921	3.543 3.740 3.937	10621 12170 13792	71714 78009 84304	8.465	1.831	2.087	5.984	0.256	M12	74	19
135	5.315	3.740 3.937 4.331	13350 15194 19177	85877 92622 106335	9.055	1.949	2.283	6.496	0.335	M14	118	24
140	5.512	3.937 4.134 4.528	14456 16300 20357	88126 94645 108134	9.055	1.949	2.283	6.693	0.335	M14	118	22
155	6.102	4.331 4.528 4.921	19545 21758 26626	108358 115552 129940	10.354	2.106	2.441	7.244	0.335	M14	118	33
165	6.496	4.724 4.921 5.315	27511 30387 36583	139832 148150 165011	11.417	2.283	2.677	7.795	0.394	M16	184	49
175	6.890	5.118 5.315 5.709	33190 36140 42778	155569 164111 180972	11.811	2.283	2.677	8.189	0.394	M16	184	51

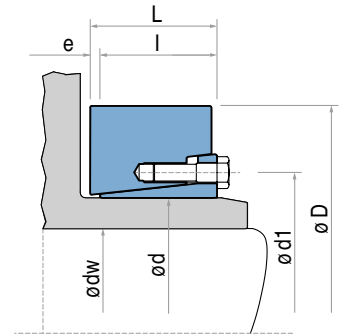

For larger diameter please contact our application engineering department.

TLK 622

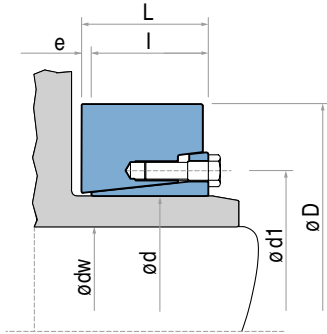

TLK 622 DIMENSIONS

Type	Customer Shaft diameter		Torque (max.)	Axial Thrust (max.)						Tightening screws DIN 931-10.9	Tightening Torque	Weight (approx.)
	d mm	d inch	M _t Lb-ft	F _{ax} Lbf	D inch	l inch	L inch	d1 inch	e inch	type	M _s Lb-ft	Lb
185	7.283	5.512	47204	205926	12.598	2.953	3.346	8.740	0.394	M16	184	73
		5.709	51629	216042								
		6.102	60480	236725								
200	7.874	5.906	59742	241221	13.386	2.953	3.346	9.370	0.394	M16	184	79
		6.102	64168	251787								
		6.496	73756	273369								
220	8.661	6.299	75969	288431	14.567	3.583	4.055	10.551	0.472	M20	361	117
		6.693	87770	313610								
		7.087	100308	339238								
240	9.449	6.693	89982	323502	15.945	3.701	4.213	11.339	0.512	M20	361	146
		7.087	103258	349580								
		7.874	132023	402410								
260	10.236	7.480	120222	385549	16.929	4.134	4.685	12.283	0.551	M20	361	181
		7.874	135711	414100								
		8.661	170376	471876								
280	11.024	8.268	158575	461085	18.110	4.567	5.197	13.150	0.630	M20	361	227
		8.661	177014	491435								
		9.449	217580	552583								
300	11.811	8.661	199141	552133	19.094	4.882	5.512	14.173	0.630	M24	620	265
		9.055	221268	585630								
		9.843	267734	653298								
320	12.598	9.449	222006	564498	20.472	4.882	5.512	14.961	0.630	M24	620	304
		9.843	244870	596871								
		10.630	293549	662065								
340	13.386	9.843	287648	700958	22.441	5.394	6.102	15.827	0.709	M24	620	417
		10.236	314938	738051								
		11.024	373205	813138								
350	13.780	10.630	363617	820332	22.835	5.591	6.378	16.299	0.787	M24	620	445
		11.024	394595	859898								
		11.417	427785	899465								
360	14.173	10.630	365830	826402	23.228	5.591	6.378	16.693	0.787	M24	620	456
		11.024	397545	865968								
		11.811	465400	945551								
380	14.961	11.417	431473	906884	25.197	5.748	6.535	17.874	0.787	M27	922	538
		11.811	466138	947574								
		12.205	502278	988490								
390	15.354	11.417	472038	991637	25.591	5.748	6.535	17.874	0.787	M27	922	549
		11.811	509654	1035250								
		12.598	589310	1123151								
420	16.535	12.598	547270	1043118	26.378	6.535	7.323	19.134	0.787	M27	922	628
		12.992	587835	1085607								
		13.780	672655	1171035								
440	17.323	13.386	696994	1249269	28.346	6.850	7.638	19.921	0.787	M27	922	787
		13.780	744198	1295805								
		14.567	843031	1389551								
460	18.110	14.173	814266	1378760	30.315	6.850	7.638	21.024	0.787	M27	922	924
		14.567	865895	1426419								
		15.354	973579	1522189								
480	18.898	14.961	958828	1538375	31.496	7.520	8.386	21.732	0.866	M30	1210	1085
		15.354	1016358	1588507								
		16.142	1136580	1689672								
500	19.685	15.748	1103390	1681129	33.465	7.520	8.386	22.520	0.866	M30	1210	1250
		16.142	1166082	1733510								
		16.929	1297368	1838946								
530	20.866	16.929	1423491	2017895	35.827	8.504	9.370	23.858	0.866	M30	1210	1640
		17.323	1497984	2075896								
		18.110	1654347	2192347								
560	22.047	17.717	1546663	2094780	37.008	8.504	9.370	24.882	0.866	M30	1210	1711
		18.110	1623370	2151881								
		18.898	1784895	2266310								
590	23.228	18.504	1912493	2480104	37.795	9.252	10.236	26.142	0.984	M30	1210	1841
		18.898	2002475	2543500								
		19.685	2190553	2670968								
620	24.409	19.685	2141874	2611393	40.157	10.276	11.260	27.795	0.984	M30	1210	2346
		20.472	2337328	2740434								
		21.260	2542369	2870149								

For larger diameter please contact our application engineering department.

TLK 623

Type	Customer Shaft diameter		Torque (max.)		Axial Thrust (max.)		Tightening screws DIN 931-10.9			Tightening Torque	Weight (approx.)	
d mm	d inch	dw inch	M _t Lb-ft	F _{ax} Lbf	D inch	l inch	L inch	d1 inch	e inch	M _t Lb-ft	Lb	
140	5.512	3.937	19177	117576	9.055	2.520	2.913	6.850	0.394	M16	184	29
		4.134	22127	126343								
		4.528	27290	144103								
155	6.102	4.331	26552	145227	10.354	2.756	3.150	7.638	0.394	M16	184	42
		4.528	29502	154444								
		4.921	35403	173553								
165	6.496	4.724	36878	186143	11.417	3.031	3.465	8.031	0.433	M16	184	57
		4.921	40566	197158								
		5.315	48679	219639								
175	6.890	5.118	44991	211996	11.811	3.031	3.465	8.425	0.433	M16	184	60
		5.315	49417	223236								
		5.709	58267	245942								
185	7.283	5.512	65643	285284	12.598	3.937	4.409	9.134	0.472	M20	361	88
		5.709	70806	298997								
		6.102	83344	327099								
200	7.874	5.906	76706	312711	13.386	3.937	4.409	9.685	0.472	M20	361	97
		6.102	83344	326649								
		6.496	95883	354525								
220	8.661	6.299	93670	357673	14.567	4.764	5.276	10.472	0.512	M20	361	141
		6.496	101046	373409								
		7.087	124648	421744								
240	9.449	6.693	115797	415224	15.945	5.118	5.669	11.260	0.551	M20	361	179
		7.087	132761	448721								
		7.874	169639	517063								
260	10.236	7.480	169639	544939	16.929	5.669	6.299	12.047	0.630	M20	361	225
		7.874	191766	584506								
		8.661	239707	664763								
280	11.024	8.268	225693	655996	18.110	6.142	6.772	13.150	0.630	M24	620	278
		8.661	252246	698035								
		9.449	308300	783463								
300	11.811	9.055	265522	704105	19.094	6.220	6.929	13.937	0.709	M24	620	311
		9.449	293549	745020								
		9.843	322314	786385								
320	12.598	9.449	317151	804820	20.472	6.535	7.244	14.724	0.709	M24	620	377
		9.843	348866	850007								
		10.630	416721	941055								
340	13.386	9.843	406396	990738	22.441	7.323	8.110	15.905	0.787	M27	922	518
		10.236	444749	1042444								
		11.024	526618	1146531								
360	14.173	10.630	494903	1117081	23.228	7.402	8.268	16.693	0.866	M27	922	553
		11.024	537681	1169911								
		11.811	628401	1276696								
390	15.354	11.417	626926	1317387	25.591	7.717	8.661	17.953	0.945	M27	922	714
		11.811	676343	1374938								
		12.598	782551	1491165								
420	16.535	12.598	742723	1414954	27.165	8.701	9.685	19.134	0.984	M27	922	902
		12.992	796565	1471831								
		13.780	910887	1586709								
440	17.323	13.386	898348	1610988	29.528	9.173	10.157	20.236	0.984	M30	1210	1160
		13.780	959566	1671013								
		14.567	1087901	1792185								
460	18.110	14.173	1034059	1751495	30.315	9.173	10.157	21.024	0.984	M30	1210	1199
		14.567	1099702	1812418								
		15.354	1237626	1934715								
480	18.898	14.961	1259015	2019693	31.496	10.630	11.732	21.732	1.102	M30	1210	1415
		15.354	1334246	2085562								
		16.142	1492084	2218200								
500	19.685	15.748	1469957	2239782	33.465	10.630	11.811	22.520	1.181	M30	1210	1634
		16.142	1553301	2309473								
		16.929	1727366	2449305								
530	20.866	16.929	1880040	2665572	35.039	12.047	13.307	24.252	1.260	M33	1630	1982
		17.323	1978873	2741783								
		18.110	2184653	2895103								
560	22.047	17.717	2092458	2834629	37.008	12.047	13.307	25.433	1.260	M33	1630	2205
		18.110	2196454	2911290								
		18.898	2413296	3065060								

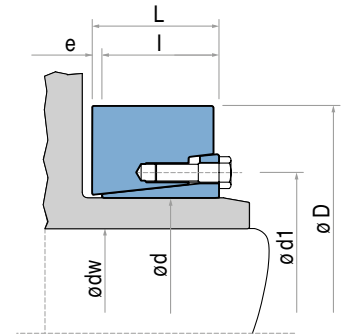

For larger diameter please contact our application engineering department.

Calculation of minimum hub diameter DM

By installing TOLLOK locking assemblies the surface pressure P_h , is exerted along the shaft and hub mating surfaces. The effect of this pressure must be considered in choosing appropriate hub material and minimum hub

thickness. Below information is provided to assist you in calculating the minimum hub diameter DM for following three application types. Factor C is based on application type.

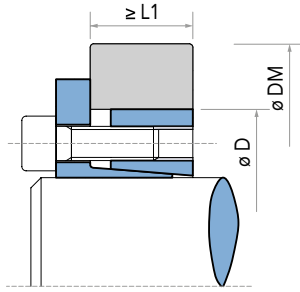

C=1

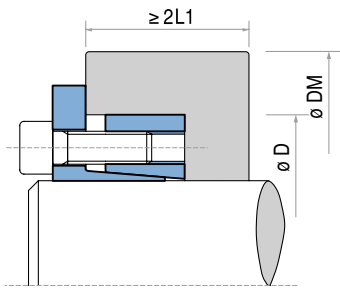
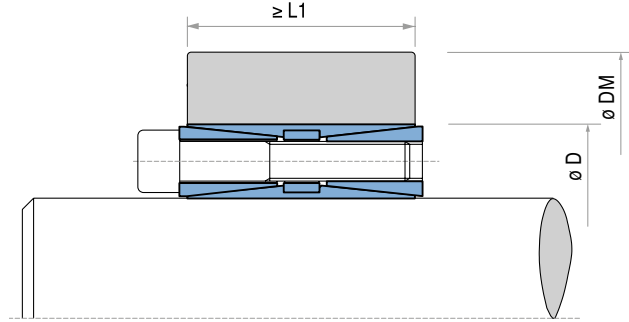

C=0,8

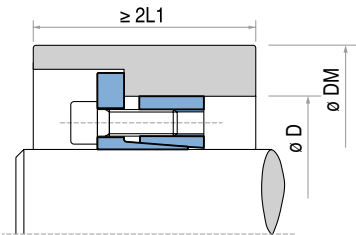
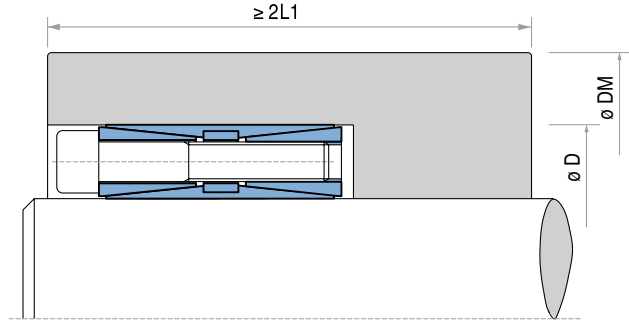

C=0,6

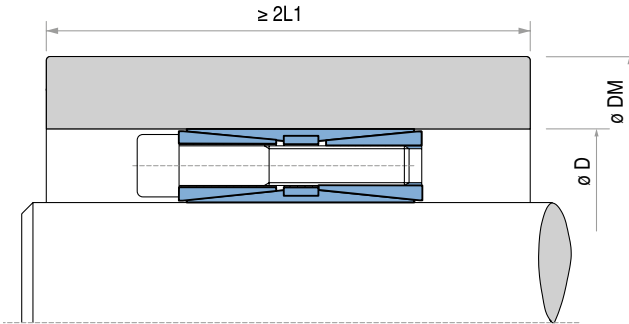

For minimum hub diameter DM calculation following formula must be applied:

$$DM \geq D \cdot K$$

where K is equal to:
$$K = \sqrt{\frac{\sigma_{02} + (C \cdot P_h)}{\sigma_{02} - (C \cdot P_h)}}$$

See page 53 for K values of selected hub materials.

Example:

Locking Assembly type TOLLOK TLK 131 $\text{H} 2 \frac{7}{16} \times 3.740$.
Hub pressure $P_h = 11346$ psi (see table page 15).

Hub material 1045 Annealed (yield strength: $\sigma_{02} = 50000$ psi)
Hub length and shape equivalent $C = 1$.

$$DM \geq 3.740 \cdot 1.26 \geq 4.712 \text{ inch}$$

Common Material

- Yield Strength (psi)
- 1045 Annealed - 50000
- 4150 Hardened - 120000
- Ductile Iron, Ferrite - 40000
- Inconel 600 - 35000
- Aluminum 356 Cast - 22000

Calculation of minimum hub diameter DM

TABLE OF COEFFICIENT K

P _h psi	Application type C	Yield point [psi]										
		21756	26107	29008	31908	36259	39160	43511	50763	58015	65267	87023
K												
8702	C = 0.6	1.28	1.25	1.20	1.18	1.15	1.14	1.12	1.10	1.09	1.08	1.06
	C = 0.8	1.39	1.30	1.24	1.23	1.22	1.20	1.18	1.15	1.12	1.11	1.08
	C = 1.0	1.52	1.42	1.36	1.32	1.28	1.25	1.22	1.18	1.16	1.14	1.10
9427	C = 0.6	1.30	1.25	1.22	1.20	1.18	1.15	1.13	1.11	1.10	1.09	1.07
	C = 0.8	1.44	1.35	1.30	1.28	1.24	1.22	1.20	1.16	1.14	1.12	1.09
	C = 1.0	1.60	1.45	1.40	1.35	1.30	1.28	1.24	1.20	1.18	1.16	1.12
10153	C = 0.6	1.34	1.26	1.24	1.22	1.18	1.16	1.15	1.12	1.11	1.10	1.07
	C = 0.8	1.48	1.38	1.34	1.30	1.25	1.23	1.20	1.18	1.15	1.13	1.10
	C = 1.0	1.65	1.50	1.45	1.40	1.34	1.30	1.26	1.22	1.20	1.17	1.13
10878	C = 0.6	1.30	1.28	1.25	1.23	1.20	1.18	1.16	1.14	1.12	1.11	1.08
	C = 0.8	1.52	1.42	1.36	1.32	1.28	1.25	1.22	1.18	1.16	1.14	1.11
	C = 1.0	1.74	1.55	1.48	1.42	1.36	1.33	1.30	1.25	1.20	1.18	1.13
11603	C = 0.6	1.39	1.31	1.28	1.25	1.21	1.20	1.18	1.15	1.13	1.11	1.08
	C = 0.8	1.58	1.45	1.39	1.35	1.30	1.27	1.24	1.20	1.18	1.15	1.11
	C = 1.0	1.81	1.61	1.53	1.46	1.39	1.36	1.31	1.26	1.22	1.20	1.14
12328	C = 0.6	1.42	1.34	1.30	1.27	1.23	1.21	1.19	1.16	1.14	1.12	1.09
	C = 0.8	1.63	1.49	1.42	1.38	1.32	1.29	1.26	1.22	1.19	1.16	1.12
	C = 1.0	1.90	1.67	1.57	1.50	1.42	1.39	1.34	1.28	1.24	1.21	1.15
13053	C = 0.6	1.46	1.36	1.32	1.28	1.25	1.22	1.20	1.17	1.15	1.13	1.09
	C = 0.8	1.69	1.53	1.46	1.40	1.34	1.31	1.28	1.23	1.20	1.18	1.13
	C = 1.0	2.00	1.73	1.62	1.54	1.46	1.41	1.36	1.30	1.26	1.22	1.16
13779	C = 0.6	1.49	1.39	1.34	1.30	1.26	1.24	1.21	1.18	1.15	1.14	1.10
	C = 0.8	1.75	1.57	1.49	1.43	1.37	1.34	1.30	1.25	1.21	1.19	1.14
	C = 1.0	2.11	1.80	1.68	1.59	1.49	1.44	1.39	1.32	1.27	1.24	1.17
14504	C = 0.6	1.53	1.41	1.36	1.32	1.28	1.25	1.22	1.19	1.16	1.14	1.11
	C = 0.8	1.81	1.61	1.53	1.46	1.39	1.36	1.31	1.26	1.22	1.20	1.14
	C = 1.0	2.24	1.87	1.73	1.63	1.53	1.48	1.41	1.34	1.29	1.25	1.18
15229	C = 0.6	1.56	1.44	1.39	1.34	1.29	1.27	1.24	1.20	1.17	1.15	1.11
	C = 0.8	1.88	1.66	1.56	1.50	1.42	1.38	1.33	1.28	1.24	1.21	1.15
	C = 1.0	2.38	1.95	1.79	1.68	1.56	1.51	1.44	1.36	1.31	1.27	1.19
15954	C = 0.6	1.60	1.47	1.41	1.36	1.31	1.28	1.25	1.21	1.18	1.16	1.12
	C = 0.8	1.96	1.71	1.60	1.53	1.44	1.41	1.35	1.29	1.25	1.22	1.16
	C = 1.0	2.55	2.04	1.86	1.73	1.60	1.54	1.47	1.38	1.33	1.28	1.20
16679	C = 0.6	1.64	1.50	1.43	1.36	1.33	1.30	1.26	1.22	1.19	1.17	1.12
	C = 0.8	2.04	1.76	1.64	1.56	1.47	1.43	1.37	1.31	1.26	1.23	1.17
	C = 1.0	2.75	2.13	1.93	1.79	1.64	1.58	1.50	1.41	1.34	1.30	1.21
17405	C = 0.6	1.69	1.53	1.46	1.40	1.34	1.31	1.28	1.23	1.20	1.18	1.13
	C = 0.8	2.13	1.81	1.69	1.60	1.50	1.45	1.39	1.33	1.28	1.24	1.18
	C = 1.0	3.00	2.24	2.00	1.84	1.69	1.61	1.53	1.43	1.36	1.31	1.22
18130	C = 0.6	1.73	1.56	1.48	1.43	1.36	1.33	1.29	1.24	1.21	1.18	1.13
	C = 0.8	2.24	1.87	1.73	1.63	1.53	1.48	1.41	1.34	1.29	1.25	1.18
	C = 1.0	3.32	2.35	2.08	1.91	1.73	1.65	1.56	1.45	1.38	1.33	1.24
18855	C = 0.6	1.78	1.59	1.51	1.45	1.38	1.35	1.30	1.25	1.22	1.19	1.14
	C = 0.8	2.35	1.93	1.78	1.67	1.56	1.50	1.44	1.36	1.30	1.27	1.19
	C = 1.0	3.74	2.49	2.17	1.97	1.78	1.69	1.59	1.48	1.40	1.35	1.25
19580	C = 0.6	1.83	1.62	1.54	1.47	1.40	1.36	1.32	1.27	1.23	1.20	1.15
	C = 0.8	2.48	2.00	1.83	1.71	1.59	1.53	1.46	1.38	1.32	1.28	1.20
	C = 1.0	4.36	2.65	2.27	2.04	1.83	1.73	1.62	1.50	1.42	1.36	1.26
20305	C = 0.6	1.88	1.66	1.56	1.50	1.42	1.38	1.33	1.28	1.24	1.21	1.15
	C = 0.8	2.63	2.07	1.88	1.75	1.62	1.55	1.48	1.39	1.33	1.29	1.21
	C = 1.0	5.39	2.83	2.38	2.12	1.88	1.78	1.66	1.53	1.44	1.38	1.27
21030	C = 0.6	1.94	1.69	1.59	1.52	1.44	1.40	1.35	1.29	1.25	1.22	1.16
	C = 0.8	2.80	2.15	1.94	1.80	1.65	1.58	1.50	1.41	1.35	1.30	1.22
	C = 1.0	7.68	3.05	2.50	2.21	1.94	1.82	1.69	1.55	1.46	1.40	1.28
21756	C = 0.6	2.00	1.73	1.62	1.54	1.46	1.41	1.36	1.30	1.26	1.23	1.16
	C = 0.8	3.00	2.24	2.00	1.84	1.69	1.61	1.53	1.43	1.36	1.31	1.23
	C = 1.0	—	3.32	2.65	2.30	2.00	1.87	1.73	1.58	1.48	1.41	1.29
22481	C = 0.6	2.06	1.77	1.65	1.57	1.48	1.43	1.38	1.31	1.27	1.24	1.17
	C = 0.8	3.25	2.33	2.06	1.89	1.72	1.65	1.55	1.45	1.38	1.33	1.23
	C = 1.0	—	3.66	2.80	2.40	2.06	1.92	1.77	1.61	1.51	1.43	1.30
23206	C = 0.6	2.13	1.81	1.69	1.60	1.50	1.45	1.39	1.33	1.28	1.24	1.18
	C = 0.8	3.55	2.43	2.13	1.94	1.76	1.67	1.58	1.47	1.39	1.34	1.24
	C = 1.0	—	4.12	3.00	2.52	2.13	1.98	1.81	1.64	1.53	1.45	1.31
23931	C = 0.6	2.21	1.86	1.72	1.62	1.52	1.47	1.41	1.34	1.29	1.25	1.18
	C = 0.8	3.96	2.55	2.21	2.00	1.80	1.71	1.60	1.49	1.41	1.35	1.25
	C = 1.0	—	4.80	3.23	2.65	2.21	2.04	1.86	1.67	1.55	1.47	1.33

Nomenclature

M_t	Lb-ft	Transmissible torque	K		Application factor for DM calculation
F_{ax}	Lbf	Permissible axial thrust	C		Variable coefficient depending on hub length and shape.
d	inch/mm	Shaft diameter	dg	mm	Screws diameter
D	inch/mm	Clamping unit outside diameter	Sf	inch	Flange thickness
L1, L2, L3, B	Inch	Clamping unit lengths	w	inch	Distance between flange and hub before tightening
M_s	Lb-ft	Screws tightening torque	i	inch	Bolt circle diameter
Pv	Lbf	Screws axial thrust	Pt	Lbf	Pre-load force necessary to compensate the clearance between shaft/TLK300/ hub for non-split elements
P_s	psi	Surface pressure on shaft	Rt	RMS	Surface finish
P_h	psi	Surface pressure on hub			
Pa	Lbf	Total thrust force necessary to transmit the required torque			
n x type		Number of bolts x bolt dia.			
DM	Inch/mm	Hub minimum diameter			
σ02	psi	Yield point of hub material			

Basic Formulas

- Calculate Torque based on horsepower (HP) and speed (RPM):

$$\text{Torque (M)} = \frac{5252 \times \text{HP}}{\text{RPM}} \quad (\text{Lb-ft})$$

- Calculate Torque transmitted based on shaft diameter (d), axial or thrust load (Axial Force), maximum or peak torque (M):

$$\text{Torque Transmitted (M}_{\text{tran}}) = \sqrt{M^2 + \left[\frac{\text{Axial Force} \times d}{24} \right]^2} \quad (\text{Lb-ft})$$

M = Maximum or peak torque (Lb-ft)
 Axial Force = Axial or thrust load (Lbf)
 d = shaft diameter (inch)

Note: **M_{tran}** value should never exceed the **M_t** value shown in the rating table of the selected unit. For assistance in selecting correct Tollok locking assemblies, rigid couplings or shrink-discs, contact our application engineering department at **866-REXNORD/866-739-6673**.

- To determine the minimum hub outside diameter (DM), follow the instructions shown on page 50.

- If bending moments are present in your application please contact our application engineering department. Typical applications like conveyor pulleys and roller conveyors where the effect of bending moments must be considered in sizing the correct Tollok product.

Unit Conversion

1 mm =	0.03937 in
1 Nm =	8.85 Lb-in
1 Nm =	0.738 Lb-ft
1 Lb-ft =	12 Lb-in
1 KN =	224.82 Lbf
1 N/mm ² =	145.04 psi
1 HP =	0.746 kW

TOLERANCE CHARTS

Hub Diameter (inch)

Over Including	0.118	0.236	0.394	0.709	1.181	1.969	3.150	4.724	7.087	9.843	12.402	15.748	19.685	24.803	31.496
	0.236	0.394	0.709	1.181	1.969	3.150	4.724	7.087	9.843	12.402	15.748	19.685	24.803	31.496	39.370

Hub Diameter (mm)

Over Including		3	6	10	18	30	50	80	120	180	250	315	400	500	630	800	
		6	10	18	30	50	80	120	180	250	315	400	500	630	800	1000	
H6 [0.0]	inch	+0.0003	+0.0004	+0.0004	+0.0005	+0.001	+0.001	+0.001	+0.001	+0.001	+0.001	+0.001	+0.002	+0.002	+0.002	+0.002	+0.002
	mm	+0.01	+0.01	+0.01	+0.01	+0.02	+0.02	+0.02	+0.03	+0.03	+0.03	+0.03	+0.04	+0.04	+0.04	+0.05	+0.06
H7 [0.0]	inch	+0.001	+0.001	+0.001	+0.001	+0.001	+0.001	+0.001	+0.001	+0.002	+0.002	+0.002	+0.002	+0.003	+0.003	+0.003	+0.004
	mm	+0.01	+0.02	+0.02	+0.02	+0.03	+0.03	+0.04	+0.04	+0.05	+0.05	+0.06	+0.06	+0.07	+0.07	+0.08	+0.09
H8 [0.0]	inch	+0.001	+0.001	+0.001	+0.001	+0.002	+0.002	+0.002	+0.002	+0.003	+0.003	+0.003	+0.004	+0.004	+0.004	+0.005	+0.006
	mm	+0.02	+0.02	+0.03	+0.03	+0.04	+0.05	+0.05	+0.06	+0.07	+0.08	+0.09	+0.10	+0.11	+0.13	+0.14	
H11 [0.0]	inch	+0.003	+0.004	+0.004	+0.005	+0.006	+0.007	+0.009	+0.010	+0.011	+0.013	+0.014	+0.016	+0.017	+0.020	+0.022	
	mm	+0.08	+0.09	+0.11	+0.13	+0.16	+0.19	+0.22	+0.25	+0.29	+0.32	+0.36	+0.40	+0.44	+0.50	+0.56	

Shaft Diameter (inch)

Over Including	0.118	0.236	0.394	0.709	1.181	1.969	3.150	4.724	7.087	9.843	12.402	15.748	19.685	24.803	31.496
	0.236	0.394	0.709	1.181	1.969	3.150	4.724	7.087	9.843	12.402	15.748	19.685	24.803	31.496	39.370

Shaft Diameter (mm)

Over Including		3	6	10	18	30	50	80	120	180	250	315	400	500	630	800
		6	10	18	30	50	80	120	180	250	315	400	500	630	800	1000
f7	inch	-0.0004	-0.0005	-0.0006	-0.0008	-0.0010	-0.0012	-0.0014	-0.002	-0.002	-0.002	-0.002	-0.003	-0.003	-0.003	-0.004
	mm	-0.010	-0.01	-0.02	-0.02	-0.03	-0.03	-0.04	-0.04	-0.05	-0.06	-0.06	-0.07	-0.08	-0.09	-0.10
g6	inch	-0.0002	-0.0002	-0.0002	-0.0003	-0.0004	-0.0004	-0.0005	-0.001	-0.001	-0.001	-0.001	-0.001	-0.001	-0.001	-0.001
	mm	-0.004	-0.01	-0.01	-0.01	-0.01	-0.01	-0.01	-0.01	-0.02	-0.02	-0.02	-0.02	-0.02	-0.02	-0.03
h6 [+0.0]	inch	-0.0003	-0.0004	-0.0004	-0.0005	-0.001	-0.001	-0.001	-0.001	-0.001	-0.001	-0.001	-0.001	-0.002	-0.002	-0.002
	mm	-0.01	-0.01	-0.01	-0.01	-0.02	-0.02	-0.02	-0.03	-0.03	-0.03	-0.04	-0.04	-0.04	-0.05	-0.06
h8 [+0.0]	inch	-0.001	-0.001	-0.001	-0.001	-0.002	-0.002	-0.002	-0.002	-0.003	-0.003	-0.004	-0.004	-0.004	-0.005	-0.006
	mm	-0.02	-0.02	-0.03	-0.03	-0.04	-0.05	-0.05	-0.06	-0.07	-0.08	-0.09	-0.10	-0.11	-0.13	-0.14
h611 [+0.0]	inch	-0.003	-0.004	-0.004	-0.005	-0.006	-0.007	-0.009	-0.010	-0.011	-0.013	-0.014	-0.016	-0.017	-0.020	-0.022
	mm	-0.08	-0.09	-0.11	-0.13	-0.16	-0.19	-0.22	-0.25	-0.29	-0.32	-0.36	-0.40	-0.44	-0.50	-0.56
j6	inch	+0.0002	+0.0003	+0.0003	+0.0004	+0.0004	+0.0005	+0.0005	+0.0006	+0.001	+0.001	+0.001	+0.001			
	mm	+0.01	+0.01	+0.01	+0.01	+0.01	+0.01	+0.01	+0.01	+0.02	+0.02	+0.02	+0.02			

Assembly and Disassembly Instruction

CAUTION: With assembly and disassembly of the locking assemblies, rigid coupling or shrink disc, it has to be made sure that the entire drive train is secured and protected against unintentional engagement. Serious bodily injury may occur from rotating parts.

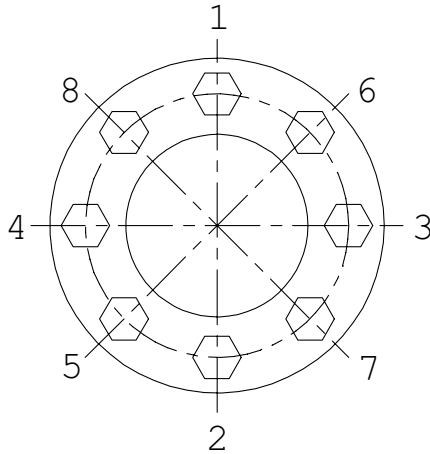

Figure 1

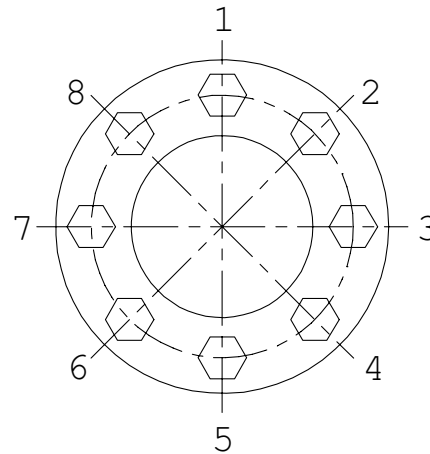

Figure 2

Figure 1 and 2 are examples of the typical tightening screw layouts. For exact number of screws refer to the appropriate Tollok unit rating table.

Assembly Instruction

- 1 Carefully clean the hub and shaft contact surfaces and apply a thin film of light-weight oil.
- 2 Slide the clamping unit into the hub bore and on to the shaft
- 3 Tighten clamping screws gradually in the cross sequence shown in Figure-1
- 4 During the first round of tightening all clamping screws, apply up to 50% of the tightening torque M_s indicated in the appropriate rating table.
- 5 Repeat above steps 3 and 4, however, this time apply 100% of the tightening torque M_s indicated in the appropriate rating table.
- 6 Apply 100% of the tightening torque M_s in continuous sequence as shown in Figure-2. Perform this step maximum twice.

Note:

- 1 Do not use any oil with Molybdenum Bisulphide, high pressure additives, or grease. These substances notably reduce the coefficient of friction.
- 2 Do not use impact wrench to loosen or tighten any of the tightening screws.
- 3 Use torque wrench to verify tightening torque value on each screws.

Disassembly Instruction

- 1 Loosen the clamping screws gradually in the cross sequence shown in Figure-1.
- 2 Do not remove the clamping screws completely.
- 3 For Tollok product type TLK400 and 401 go to step 6, otherwise stop after step 5.
- 4 Insert the screws into the dismantling threads of the front cone or inner ring and tighten gradually in the cross sequence shown in Figure-1.
- 5 In case of difficulties lightly hammer the releasing screws. Slide out Tollok unit from the hub/shaft.
- 6 Continue further for product type TLK400 and 401.
- 7 Remove all clamping screws. Insert the releasing screws in to the threaded holes of the front cone.
- 8 Righten releasing screws gradually in the cross sequence shown in Figure-1.
- 9 During the first round of tightening all releasing screws, apply up to 50% of the tightening torque M_s indicated in the appropriate rating table.
- 10 Repeat above steps 7 and 8, however, this time apply 100% of the tightening torque M_s indicated in the appropriate rating table.
- 11 Remove the front cone and repeat steps 7 through 9 after inserting removing screws in to the middle ring. This will release the back cone.

Note:

- 1 If the element is to be reused, through clean all the elements surfaces lubricate both screws and threads prior to its use with a thin film of light-weight oil.
- 2 Do not use impact wrench to loosen or tighten any of the tightening screws.

Ordering Example

To learn more about the Tollok offering, please contact us today:

866-REXNORD/866-739-6673 (Within the U.S.) +39 0532 816911 (Outside the U.S.)

Or visit our website **WWW.REXNORD.COM** for more information.

Company Name:.....

Contact Name:.....

Address:.....

Phone No.:.....

Fax No.:.....

Email:.....

Information Required To Order Tollok Product

	Example 1	Example 2	Example 3
Quantity:	50	100	500
Unit Type:	TLK200	TLK603	TLK450
Unit Size:			
d = inch / mm	2 7/16 inch	90 mm	6 inch
D = inch / mm	3.740 inch	6.102 inch	8.268 inch
dw* = inch / mm		2 3/4 inch	
*dw dia. required with TLK6 (shrink disk)			
Special Options			
<input type="checkbox"/> Paint finish	<input type="checkbox"/>	<input checked="" type="checkbox"/>	<input type="checkbox"/>
RAL No.:		RAL 7016	
<input type="checkbox"/> Nickel Plating	<input checked="" type="checkbox"/>	<input type="checkbox"/>	<input type="checkbox"/>
<input type="checkbox"/> Special Packaging Instructions	<input type="checkbox"/>	<input type="checkbox"/>	<input type="checkbox"/>



866-REXNORD/866-739-6673 (Within the U.S.)
+39 0532 816911 (Outside the U.S.)
www.rexnord.com

Why Choose Rexnord?

When it comes to providing highly engineered products that improve productivity and efficiency for industrial applications worldwide, Rexnord is the most reliable in the industry. Commitment to customer satisfaction and superior value extend across every business function.

Delivering Lowest Total Cost of Ownership

The highest quality products are designed to help prevent equipment downtime and increase productivity and dependable operation.

Valuable Expertise

An extensive product offering is accompanied by global sales specialists, customer service and maintenance support teams, available anytime.

Solutions to Enhance Ease of Doing Business

Commitment to operational excellence ensures the right products at the right place at the right time.

REXNORD

Rexnord Company Overview

Rexnord is a growth-oriented, multi-platform industrial company with leading market shares and highly trusted brands that serve a diverse array of global end markets.

Process & Motion Control

The Rexnord Process & Motion Control platform designs, manufactures, markets and services specified, highly engineered mechanical components used within complex systems where our customers' reliability requirements and the cost of failure or downtime are extremely high.

Water Management

The Rexnord Water Management platform designs, procures, manufactures and markets products that provide and enhance water quality, safety, flow control and conservation.